

台灣精製 · 收納美學

廚房衛浴不鏽鋼系列產品

Stainless Steel

Kitchen / Bathroom Accessories And Holders

DAY&DAY
Quality for everyday living
2024



CONTENTS – 衛浴不鏽鋼系列產品

DAY & DAY 品牌介紹	01
安裝前注意事項	02
精緻霧黑	
304 不鏽鋼 毛巾置衣架、單 / 雙毛巾掛桿組、手機座架、單掛衣勾	03
304 不鏽鋼 置物架	04
絲光系列	
單 / 雙桿毛巾掛桿組、毛巾置衣架	05
毛巾置衣架、扶手、吹風機架	06
心形 / 扇形 / 方形置物架 / 轉角架 / 雙層轉角架 / 手機座架	07
單掛衣勾 / 雙掛衣勾、馬桶刷架	08
牙刷杯架、香皂盤架、浴巾環	09
上櫃固定座、掛桿固定座、掛桿	11
掛勾、掛架固定座	12
不鏽鋼鏡面拋光毛巾桿 Towel bar	
STH2600 系列、STH2700 系列、STH6100 單桿 / 雙桿 系列	13
單層轉角架、單層方形、ST3268 系列置物架	14
毛巾置衣架 Towel & Clothes rack	15-16
單層、雙層、三層轉角架 / 單層、雙層、三層方形架、面紙架	17-20
衛浴配件 Bath accessories	21-24
旋轉直立架 Swivel stand 雙層、三層旋轉直立架	25-26
LED 鏡、易潔鏡、防霧鏡	27-28
3500 銅 平台固定座系列	29
STH3700	
304 不鏽鋼鏡面拋光 – 平台固定座系列	30

- 產品規格及品項價格若有調整，以實際商品為準，恕不另行通知。
- 本目錄之產品售價自 2024 年 1 月 1 日起為準。

CONTENTS – 廚房不鏽鋼系列產品

刀柄 & 砧板架 Knife, carving board holder.....	31
調味罐架 & 砧板架 Spice, carving board holder.....	32-35
紙巾架、隔熱墊 Paper towerrack、Hot mat.....	35
鍋蓋架 Lid rack.....	36
碗盤架 Bowl & Dishes holder.....	37-38
桌上型碗盤架、紅酒架 Tableware bowl & Dishes Holder、Wine Holder.....	39
滴水簾、水槽碗盤籃 Rollable dishes holder & Sink basket rack.....	40
餐具桶、水杯架、蛋糕架 Silver ware holder、Cup stand、Cake holder.....	41-42
餐具架、小型置物架 Spoon holder、Small rack.....	43
高腳杯架、餐具 Goblet, Hanging rack, Tableware holder.....	44
感應垃圾桶 Auto sensitive dustbin.....	45
腳踏式垃圾桶 Dustbin.....	46
Awa FAUCET 品牌專區	
AWA 品牌介紹.....	47-48
AWA 檯面龍頭 AWA faucet.....	49-53
AWA 龍頭 配件介紹 AWA accessories.....	54
AWA 浴室感應式龍頭 AWA auto faucet.....	55
AWA 浴室龍頭 AWA faucet.....	56-58
龍頭 Faucet.....	59-64
水槽 Dish Sink.....	65-66
環保防蟻防臭新型專利不鏽鋼後置型提籠產品特色說明.....	67
龍頭配件 Faucet accessories.....	68
經典絕版品.....	69-72



關於我們

營造現代舒適的生活空間，必定伴隨著良好的收納設計。DAY&DAY日日家居生活精品自1989年創立以來，以扮演優質生活的幕後推手為理念，致力於開發各式功能的掛架及收納置物架。DAY&DAY以人性為設計的價值，以機能性、高品質、及簡潔美感為設計理念，設計製造出貼近使用者的不鏽鋼生活用品。

DAY & DAY家居生活精品，配合國人各種生活需求的收納功能設計，並採用高品質304(18-8)不鏽鋼，加上頂級電鍍表面處理，針對潮濕的廚房、浴室環境，達到最高的防鏽抗腐蝕的效果，是最衛生且容易保養清理的廚衛必需品，簡潔設計能完美搭配各種的室內居家風格，創造出便利舒適的生活環境！

材質說明

不鏽鋼指的是以重量計，鉻含量超過11.5%的鐵合金。這個名稱源於這類的鋼材，不像普通鋼那樣容易腐蝕生鏽。而不鏽鋼也俗稱白鐵，擁有優良的耐酸、耐熱、耐蝕性，且表面不需再經處理，性質較碳鋼佳。常使用於廚房餐具、醫療衛生器材、食品加工用材。

304不鏽鋼即為此類，其標準成分是18%鉻加8%鎳，即一般所稱的18-8不鏽鋼。此類不鏽鋼的特性為無磁性，於加工過程中會出現弱磁性，無法藉由熱處理方法來改變其金相組織結構、加工性佳，又因含合金元素--鎳，所以抗蝕性較優。

商品特色

- MIT台灣設計製造精品
- 高品質304不鏽鋼材質
- 頂級鍍鉻表面防護處理
- 最佳收納功能產品設計
- 品項齊全滿足多元需求

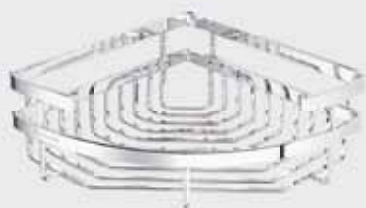

如何保養不鏽鋼

定時保養請以溫水或稀釋之軟性清潔劑配合海綿清洗，即可輕易去除污垢，如因水中含鐵礦物質造成的表面鏽斑再以檸檬水輕拭表面，可永保亮麗如新。

亦可搭配本公司代理進口之義大利 ARGITAL 純天然植物配方之環保金屬清潔劑，安全無毒，保養效果更佳，請洽詢 DAY&DAY 全台專櫃。

天然植物生態環保清潔劑，不含防腐劑，不傷玉手。含有天然萃取精油成分，除了不改變空氣品質之外，在使用的空間中，讓深呼吸是一件享受的事。



使用方式：直接噴灑於金屬物體表面，稍作停留，以水沖洗或以海綿洗淨。

UI2088 NT\$ 600

- 環保金屬清潔劑
- 含甜橙精油、薄荷精油
- 義大利原裝進口



使用方式：直接噴灑於玻璃表面，稍作停留，再以乾布或報紙擦拭。

UI2085 NT\$ 600

- 環保玻璃清潔劑
- 含甜橙精油
- 義大利原裝進口





安裝前注意事項

- 施工鑽頭為配合白色壁虎，請使用直徑 6.5~7mm 為宜。
- 不同類型的廚房掛架產品，及衛浴產品，考量不同的使用情況及承載，均有專用的螺絲(配件包)類型及長度，請勿混用。
- 產品表面應避免使用或接觸到強酸性清潔劑(如鹽酸、磁磚清潔劑)，會導致電鍍表面受損。
- **壁面產品固定墊片安裝說明**

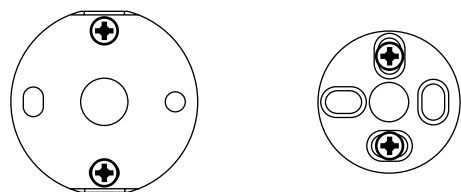

螺絲固定以上下兩點墊片承載力最佳

• 掛架固定座 (5000C-2、5000SC-2、5000LC-2) 安裝說明

單面貼壁掛架商品，固定座宜採該商品吊掛處兩端最外側，同時於將來欲清潔時掛架仍可直接提起取下位置。

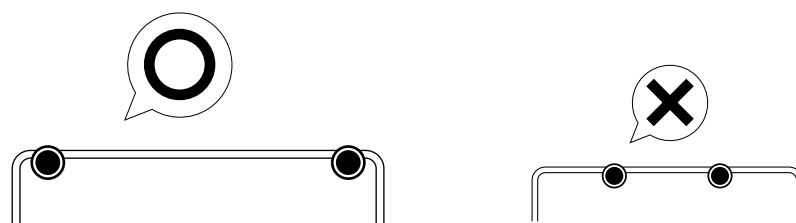

轉角式兩面貼壁掛架商品，固定座應選任單一邊吊掛處兩端最外側，同時於將來欲清潔時掛架仍可直接提起取下位置，應避免兩面各裝一顆方式。

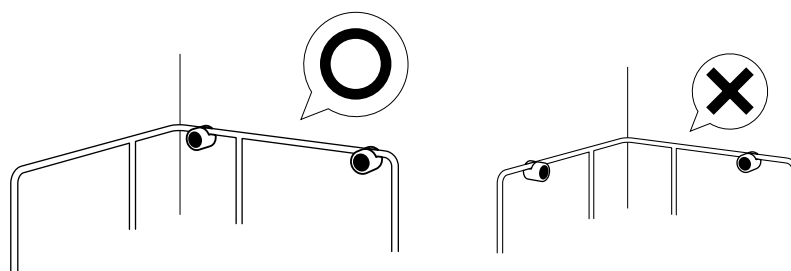

NEW



C0025BK NT\$ 4900

- 毛巾置衣架
- 304 不鏽鋼 黑色
- TOWEL & CLOTHES SHELF
- 304 STAINLESS STEEL
- W600 X D220 X H125MM



C0056BK NT\$ 3600

- 毛巾置衣架
- 304 不鏽鋼 黑色
- TOWEL & CLOTHES SHELF
- 304 STAINLESS STEEL
- W645 X D220 X H120MM



C0021BK-60 60CM NT\$ 2700

C0021BK-75 75CM NT\$ 3000

- 單桿毛巾掛桿組
- 304 不鏽鋼 黑色
- TOWEL BAR
- 304 STAINLESS STEEL
- 掛桿固定座 W55 X H55MM
- 內距深度 70MM



C0022BK-60 60CM NT\$ 3200

C0022BK-75 75CM NT\$ 3500

- 雙桿毛巾掛桿組
- 304 不鏽鋼 黑色
- TWIN TOWEL BAR
- 304 STAINLESS STEEL
- 掛桿固定座 W55 X H55MM
- 內距 50MM / 內桿至外桿距離 60MM



C0039BK NT\$ 2400

- 手機及捲筒衛生紙架
- 304 不鏽鋼 黑色
- PAPER ROLL & PHONE HOLDER
- 304 STAINLESS STEEL
- W180 X D100 X H95MM



C0023BK NT\$ 1000

- 單掛衣勾
- 304 不鏽鋼 黑色
- SINGLE ROBE HOOK
- 304 STAINLESS STEEL
- W55 X D63 X H55MM



C0062BK NT\$ 2400

(實景詳見右下)

- 扇形轉角架
- 304 不鏽鋼 黑色
- CORNER RACK
- 304 STAINLESS STEEL
- W230 X D230 X H80MM



C0063BK NT\$ 2000

- 抽取式衛生紙架
- 304 不鏽鋼 黑色
- FACIAL TISSUE HOLDER
- 304 STAINLESS STEEL
- W261 X D152 X H60MM



C0065BK NT\$ 2200

- 置物架
- 304 不鏽鋼 黑色
- MULTI-PURPOSE RACK
- 304 STAINLESS STEEL
- W242 X D133 X H68MM



304 不鏽鋼 絲光系列

NEW



ST1300 NT\$ 4100

- 絲光 毛巾置衣架
- 304 不鏽鋼 絲光
- TOWEL & CLOTHES SHELF
- 304 STAINLESS STEEL
- W603 X D243 X H150MM



ST1300S NT\$ 3850

- 絲光 毛巾置衣架
- 304 不鏽鋼 絲光
- TOWEL & CLOTHES SHELF
- 304 STAINLESS STEEL
- W450 X D243 X H150MM



ST1360 60CM NT\$ 1800

ST1375 75CM NT\$ 1950

ST1390 90CM NT\$ 2100

- 絲光 單桿毛巾掛桿組 5 分管
- 304 不鏽鋼 絲光固定座
- 304 不鏽鋼 絲光掛桿
- TOWEL BAR
- 304 STAINLESS STEEL
- 掛桿固定座 Ø54 X H79 (內距 58MM)



ST1560 60CM NT\$ 3150

ST1575 75CM NT\$ 3300

ST1590 90CM NT\$ 3500

- 絲光 雙桿毛巾掛桿組 5 分管
- 304 不鏽鋼 絲光固定座
- 304 不鏽鋼 絲光掛桿
- TWIN TOWEL BAR
- 304 STAINLESS STEEL
- 掛桿固定座 Ø54 X H79，總高 145MM
- 低桿內距 127MM，高桿內距 60MM



STA0051-60 60CM NT\$ 1900

STA0051-75 75CM NT\$ 2100

STA0051-90 90CM NT\$ 2400

- 絲光 單桿毛巾掛桿組
- 304 不鏽鋼 絲光
- TOWEL BAR
- 304 STAINLESS STEEL
- 掛桿固定座 W38 X D70 X H20MM
(內距深度 65MM)



STA0052-60 60CM NT\$ 2400

STA0052-75 75CM NT\$ 2600

STA0052-90 90CM NT\$ 2900

- 絲光 雙桿毛巾掛桿組
- 304 不鏽鋼 絲光
- TWIN TOWEL BAR
- 304 STAINLESS STEEL
- 掛桿固定座 W38 X D115 X H20MM
- 內距 44MM / 內桿至外桿距離 54MM

304 不鏽鋼 絲光系列



STA0053 NT\$ 4100

- 絲光 毛巾置衣架
- 304 不鏽鋼 絲光
- TOWEL & CLOTHES SHELF
- 304 STAINLESS STEEL
- W600 X D220 X H116MM



STA0056 NT\$ 2800

- 絲光 毛巾置衣架
- 304 不鏽鋼 絲光
- TOWEL & CLOTHES SHELF
- 304 STAINLESS STEEL
- W645 X D220 X H120MM



STA0055 NT\$ 2100

- 絲光 置衣架
- 304 不鏽鋼 絲光
- CLOTHES SHELF
- 304 STAINLESS STEEL
- W650 X D220 X H50MM



ST1630	30CM	NT\$ 1600
ST1640	40CM	NT\$ 1750
ST1650	50CM	NT\$ 1900
ST1660	60CM	NT\$ 2050

- 絲光 扶手
- 304 不鏽鋼 絲光
- GRAB BAR
- 304 STAINLESS STEEL



STA0033 NT\$ 1100

- 絲光 吹風機架
- 304 不鏽鋼 絲光
- 適用負離子吹風機
- HAIR DRYER HOLDER
- 304 STAINLESS STEEL
- W150 X D114 X H22MM
- 圓內徑 86MM



ST1019 NT\$ 1450

- 絲光 吹風機架
- 304 不鏽鋼 絲光
- HAIR DRYER HOLDER
- 304 STAINLESS STEEL
- W100 X D118 X H110MM

304 不鏽鋼 絲光系列



STA0061 NT\$ 2000

- 絲光 心形置物架
- 304 不鏽鋼 絲光
- HEART CORNER RACK
- 304 STAINLESS STEEL
- W250 X D250 X H85MM



STA0062 NT\$ 2000

- 絲光 扇形轉角架
- 304 不鏽鋼 絲光
- CORNER RACK
- 304 STAINLESS STEEL
- W230 X D230 X H80MM



STA0063 NT\$ 1500

- 絲光 抽取式衛生紙架
- 304 不鏽鋼 絲光
- FACIAL TISSUE HOLDER
- 304 STAINLESS STEEL
- W261 X D152 X H60MM



STA0065 NT\$ 1800

- 絲光 置物架
- 304 不鏽鋼 絲光
- MULTI-PURPOSE RACK
- 304 STAINLESS STEEL
- W242 X D132 X H68MM



NEW

STA0066-2 NT\$ 3800

- 絲光 雙層轉角架
- 304 不鏽鋼 絲光
- CORNER RACK DOUBLE
- 304 STAINLESS STEEL
- W215 X D215 X H415MM
- 內徑高度 315MM



STA0039 NT\$ 1500

- 絲光 手機及捲筒衛生紙架
- 304 不鏽鋼 絲光
- PAPER ROLL & PHONE HOLDER
- 304 STAINLESS STEEL
- W180 X D100 X H95MM



NEW

ST1021 NT\$ 2900

- 絲光 轉角架
- 304 不鏽鋼 絲光
- CORNER RACK
- 304 STAINLESS STEEL
- W226 X D226 X H75MM



NEW

ST1022 NT\$ 2700

- 絲光 方型置物架
- 304 不鏽鋼 絲光
- MULTI-PURPOSE RACK
- 304 STAINLESS STEEL
- W265 X D122 X H75MM

304 不鏽鋼 絲光系列



STA0037

NT\$ 700

- 絲光 單掛衣勾
- 304 不鏽鋼 絲光
- SINGLE ROBE HOOK
- 304 STAINLESS STEEL
- 固定座 Ø 28MM
- W29 X D50 X H65MM



STA0038

NT\$ 800

- 絲光 雙掛衣勾
- 304 不鏽鋼 絲光
- DOUBLE ROBE HOOK
- 304 STAINLESS STEEL
- 固定座 W38 X H20MM
- W90 X D60 X H24MM



ST1016

NT\$ 1200

- 絲光 單掛衣勾
- 304 不鏽鋼 絲光
- SINGLE ROBE HOOK
- 304 STAINLESS STEEL
- Ø 50MM
- W50 X D67 X H62MM



ST1017

NT\$ 1300

- 絲光 雙掛衣勾
- 304 不鏽鋼 絲光
- DOUBLE ROBE HOOK
- 304 STAINLESS STEEL
- Ø 50MM
- W77 X D67 X H50MM



ST1012

NT\$ 1700

- 絲光 馬桶刷架
- 304 不鏽鋼 絲光
- 附馬桶刷 & 霧面馬桶刷杯
- TOILET BRUSH & GLASS CUP WITH HOLDER
- 304 STAINLESS STEEL
- W155 X D120 X H355MM
- 圓內徑 85MM



STA0035

NT\$ 1500

- 絲光 馬桶刷架
- 304 不鏽鋼 絲光
- 附馬桶刷 & 霧面玻璃杯
- TOILET BRUSH & GLASS CUP WITH HOLDER
- 304 STAINLESS STEEL
- W159 X D125 X H345MM
- 圓內徑 86MM



STA0036

NT\$ 150

- 絲光 馬桶刷
- 304 不鏽鋼 絲光
- TOILET BRUSH
- 304 STAINLESS STEEL
- W335MM



1025

NT\$ 250

- 霧面玻璃 馬桶刷杯
- TOILET BRUSH CUP
- GLASS
- Ø115 X H112MM

304 不鏽鋼 絲光系列



STA0031 NT\$ 1100

- 絲光 牙刷杯架
- 304 不鏽鋼 絲光
- 附透明玻璃杯 GLASS CUP
- CUP WITH HOLDER
- 304 STAINLESS STEEL
- W125 X D100 X H95MM



ST1001 NT\$ 1350

- 絲光 牙刷杯架
- 304 不鏽鋼絲光
- 附霧面玻璃杯 GLASS CUP
- TUMBLER CUP WITH HOLDER
- 304 STAINLESS STEEL
- W120 X D90 X H96MM



ST1002 NT\$ 1750

- 絲光 牙刷雙杯架
- 304 不鏽鋼絲光
- 附霧面玻璃雙杯 GLASS CUP X 2
- TUMBLER CUP WITH HOLDER
- 304 STAINLESS STEEL
- W193 X D90 X H96MM



ST1006 NT\$ 1300

- 絲光 浴巾環
- 304 不鏽鋼 絲光
- BIGGER TOWER RING
- 304 STAINLESS STEEL
- W170 X D66 X H190MM
- 圓內徑 152MM



STA0032 NT\$ 1100

- 絲光 香皂盤架
- 304 不鏽鋼 絲光
- 附透明玻璃 香皂盤 GLASS SOAP
- SOAP DISH WITH HOLDER
- 304 STAINLESS STEEL
- W145 X D120 X H40MM



ST1003 NT\$ 1350

- 絲光 香皂盤架
- 304 不鏽鋼絲光
- 附霧面玻璃皂盤 GLASS SOAP
- SOAP DISH WITH HOLDER
- 304 STAINLESS STEEL
- W140 X D110 X H54MM



1023 NT\$ 130

- 透明玻璃 牙刷杯
- TOOTH-BRUSH CUP
- GLASS
- Ø70 X H95MM



1024 NT\$ 180

- 透明玻璃 香皂盤
- SOAP DISH
- GLASS
- Ø110 X H40MM



ST1005 NT\$ 1350

- 絲光 捲筒衛生紙架
- 304 不鏽鋼絲光
- PAPER HOLDER WITH LID
- 304 STAINLESS STEEL
- W133 X D70 X H135MM



DAY & DAY
Quality for everyday living

上櫃用掛桿頭

NEW



2900-2 NT\$ 900 / 一對
2900 (中通) NT\$ 450 / 一個
 (實景詳見左圖)

- 掛桿上櫃固定座 (霧面)
- 上櫃側板用
- HOLDER
- ALUMINUM 鋁
- W17 X D90 X H75MM



2500-2 NT\$ 900 / 一對
2500 (中通) NT\$ 450 / 一個
 (實景詳見頁 44 左上)

- 掛桿上櫃固定座 (霧面)
- HOLDER
- ALUMINUM 鋁
- W25 X D62 X H70MM



NEW



STH2600-2 掛桿頭 NT\$ 1300 / 一對
STH2600M (中通) NT\$ 650 / 一個

- 掛桿固定座
- HOLDER
- 304 STAINLESS STEEL 不鏽鋼
- 304 不鏽鋼鏡面拋光
- ϕ 25 X D62MM



STH2700-2 掛桿頭 NT\$ 1600 / 一對
STH2700M (中通) NT\$ 800 / 一個
 (實景詳見頁 15、32)

- 掛桿固定座
- HOLDER
- 304 STAINLESS STEEL 不鏽鋼
- 304 不鏽鋼鏡面拋光
- W23 X D62 X H23MM



2500-A-2 NT\$ 50 / 2 入

- 5 分管 矽膠塞頭



3000C-2 掛桿頭 NT\$ 500 / 一對
3000M (中通) NT\$ 250 / 一個

- 掛桿固定座
- HOLDER
- CHROME PLATING 不鏽鋼色
- ZINC DIE CAST 鋅合金
- W30 X D60 X H66MM



5200C 不鏽鋼色 NT\$ 120 / 一對

- 吊衣座 (一對)
- DRESS-HANGER HOLDERS/PAIR
- BRASS 青銅料
- 5 分管適用



ST2045 45CM NT\$ 200
ST2060 60CM NT\$ 250
ST2075 75CM NT\$ 300
ST2090 90CM NT\$ 400
ST2120 120CM NT\$ 500
ST2150 150CM NT\$ 700
ST2180 180CM NT\$ 950

- 亮麗不鏽鋼管
- THICKNESS 厚度 0.8~1.2MM
- 304 STAINLESS STEEL
- ϕ 16MM (5 分管)



ST3001-5 NT\$ 500

- 五聯勾 附固定頭
- W340MM

ST3001-8 NT\$ 650

- 八聯勾 附固定頭
- W492MM
- HOOK RAILS
- 304 STAINLESS STEEL



ST3001-5S NT\$ 350

- 五聯勾
- W335MM

ST3001-8S NT\$ 500

- 八聯勾
- W462MM
- 可另選購 7000C-2 或 7200C-2 螺絲固定頭
- HOOK RAILS
- 304 STAINLESS STEEL



STC0103 NT\$ 760

- 三聯掛衣勾
- ROBE HOOK RAILS
- 304 STAINLESS STEEL
- W280 X D53 X H85MM



4000C-2 NT\$ 240/一對

- 掛架固定座
- HOLDER
- CHROME PLATING 不鏽鋼色
- BRASS 青銅材質
- ϕ 19 X D57MM



5000C-2 (薄底) NT\$ 150 / 一對

- ϕ 20 X D21MM

5000SC-2 (厚底) NT\$ 150 / 一對

- ϕ 20 X D25MM

5000LC-2 (薄底) NT\$ 270 / 一對

- ϕ 29 X D27MM

- 掛架固定座
- HOLDER
- CHROME PLATING 不鏽鋼色
- BRASS 青銅材質



7000C-2 NT\$ 120/一對

- 螺絲固定頭 螺帽青銅材質
- 螺帽 CHROME PLATING 不鏽鋼色
- ϕ 13 X D12MM
- 適用品項
ST3001-5S, ST3001-8S
ST3267, ST6632



7200C-2 NT\$ 190/一對

- 螺絲固定頭 螺帽青銅材質
- 螺帽 CHROME PLATING 不鏽鋼色
- 適用品項
ST3001-5S ST3001-8S
ST3205 ST3205T ST3208
ST3208A ST3208A-2 ST3209
ST3209-2 ST3267
ST5230A ST6632
ST3266 ST3266-01



ST3001-3 NT\$ 190 /3 入
(實景詳見頁 44)

- 單 S 掛勾
- S-HOOK SINGLE
- 304 STAINLESS STEEL



ST3002 NT\$ 110

(實景詳見頁 34)

- 單 S 掛勾
- S-HOOK SINGLE
- 304 STAINLESS STEEL



ST3036 NT\$ 250

- 砧板掛勾
- CARVING BOARD HOOK
- 304 STAINLESS STEEL
- W72 X D112 X H75MM



3000 系列 (5 分管)

3245C	不鏽鋼色	45CM	NT\$700
3260C	不鏽鋼色	60CM	NT\$750
3275C	不鏽鋼色	75CM	NT\$800
3290C	不鏽鋼色	90CM	NT\$900

- 單桿毛巾掛桿組
- 鋅合金固定座 +304 不鏽鋼掛桿
- TOWEL BAR
- ZIN DIE CAST HOLDER
- 304 STAINLESS STEEL TUBE
- 掛桿固定座 W30 X D60 X D66MM (內距 40MM)

NEW



STH2600 系列 (5 分管)

STH2645C	45CM	NT\$1500
STH2660C	60CM	NT\$1550
STH2675C	75CM	NT\$1600
STH2690C	90CM	NT\$1700

- 單桿毛巾掛桿組
- 304 不鏽鋼鏡面拋光掛桿固定座 +304 不鏽鋼掛桿
- TOWEL BAR
- 304 STAINLESS STEEL HOLDER
- 304 STAINLESS STEEL TUBE
- 掛桿固定座 Ø25 X D62MM (內距 40MM)



2312-2 不鏽鋼色 120CM NT\$2450



2360-2 不鏽鋼色 60CM NT\$1400

2375-2 不鏽鋼色 75CM NT\$1500

2390-2 不鏽鋼色 90CM NT\$1700

- 雙桿毛巾掛桿組 4 分管
- 青銅掛桿固定座 + #304 不鏽鋼掛桿
- TWIN TOWEL BAR
- 304 STAINLESS STEEL TUBE
- 掛桿固定座 38XD116MM
- (內距 45MM/ 內桿至外桿距離 32MM) (4 分管)

NEW



STH2700 系列 (5 分管)

STH2745	45CM	NT\$1800
STH2760	60CM	NT\$1850
STH2775	75CM	NT\$1900
STH2790	90CM	NT\$2000

- 單桿毛巾掛桿組
- 304 不鏽鋼鏡面拋光固定座 +304 不鏽鋼掛桿
- TOWEL BAR
- 304 STAINLESS STEEL HOLDER
- 304 STAINLESS STEEL HOLDER TUBE
- 掛桿固定座 Ø22 X D62MM (內距 40MM)



ST2168 NT\$900

- 毛巾架
- TOWEL SHELF
- 304 STAINLESS STEEL
- W660 X D98 X H60MM
- 6 分管 (內距 75MM)



ST2169S NT\$650

- W480 X D96 X H30MM

ST2169L NT\$750

- W630 X D96 X H30MM

- 毛巾架
- TOWEL SHELF
- 304 STAINLESS STEEL
- 6 分管 (內距 65MM)



STA0012-60 60CM NT\$ 1500

STA0012-75 75CM NT\$ 1700

- 單桿毛巾掛桿組
- 304 不鏽鋼
- TOWEL BAR
- 304 STAINLESS STEEL
- 掛桿固定座 Ø60MM (內距 62MM)



STH6100 不鏽鋼系列 (4 分管)

STH6160	60CM	NT\$2100
STH6175	75CM	NT\$2150
STH6190	90CM	NT\$2250

- 單桿毛巾掛桿組
- 304 不鏽鋼鏡面拋光固定座 +304 不鏽鋼掛桿
- TOWEL BAR
- HOLDER & TUBE
- 304 STAINLESS STEEL
- 掛桿固定座 Ø38 X D87MM (內距 62MM)



STH6100 不鏽鋼系列 (4 分管)

STH6160-2	60CM	NT\$2650
STH6175-2	75CM	NT\$2750
STH6190-2	90CM	NT\$2950

(實景詳見左圖)

- 雙桿毛巾掛桿組
- 304 不鏽鋼鏡面拋光固定座 +304 不鏽鋼掛桿
- TWIN TOWEL BAR
- 304 STAINLESS STEEL HOLDER & TUBE
- 掛桿固定座 Ø38 X D114MM (內距 46MM/ 內桿至外桿距離 36MM)





ST3266-01 NT\$ 1950

- 轉角架
- CORNER RACK
- 304 STAINLESS STEEL
- W230 X D235 X H57MM



ST3266 NT\$ 2300

(實景詳見頁 19)

- 轉角架
- CORNER RACK
- 304 STAINLESS STEEL
- W230 X D235 X H95MM

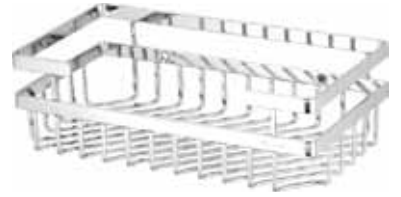

ST3267 NT\$ 2650

- 單層置物架
- 可另選購 7000C-2
或 7200C-2 螺絲固定座
- SINGLE RACK
- 304 STAINLESS STEEL
- W320 X D170 X H100MM

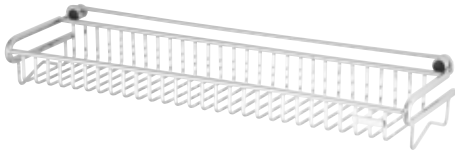

ST3268XL NT\$ 3050

- 平台置物架 (扁型線條)
- 附 5000SC-2 掛架固定座 厚底
- SINGLE MULTI-PURPOSE RACK
- 304 STAINLESS STEEL
- W600 X D160 X D90MM

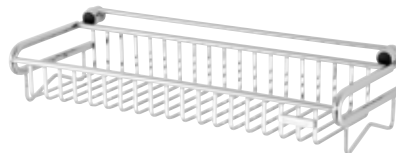

ST3268-1 NT\$ 2500

(實景詳見頁 24)

- 單層置物架(扁型線條)
- 附5000SC-2掛架固定座 厚底
- SINGLE MULTI-PURPOSE RACK
- 304 STAINLESS STEEL
- W420 X D160 X D90MM

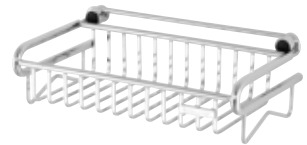

ST3268-1S NT\$ 1950

- 單層置物架-窄版(扁型線條)
- 附5000SC-2掛架固定座 厚底
- SINGLE MULTI-PURPOSE RACK
- 304 STAINLESS STEEL
- W275 X D160 X H90MM



ST3268 NT\$ 4500

- 雙層置物架(扁型線條、強化玻璃6MM)
- 附5000SC-2掛架固定座 厚底
- DOUBLE MULTI-PURPOSE RACK
- 304 STAINLESS STEEL
- W470 X D260 X H340MM
- 內徑高度 250MM



ST3268-2 NT\$ 4850

- 雙層置物架(扁型線條)
- 附5000SC-2掛架固定座 厚底
- DOUBLE MULTI-PURPOSE RACKS
- 304 STAINLESS STEEL
- W420 X D160 X D380MM
- 內徑高度 285MM

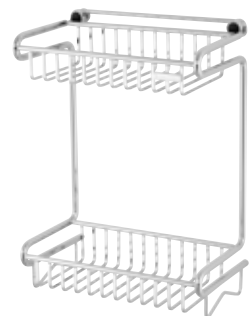

ST3268-2S NT\$ 3750

- 雙層置物架-窄版(扁型線條)
- 附5000SC-2掛架固定座 厚底
- DOUBLE MULTI-PURPOSE RACKS
- 304 STAINLESS STEEL
- W275 X D160 X H380MM
- 內徑高度 285MM



ST2298SD-02 NT\$ 4000

- 雙層毛巾及多功能架 - 單桿
- 附 5000LC-2 掛架固定座
- TOWEL SHELF & DOUBLE MULTI-PURPOSE RACK
- 304 STAINLESS STEEL
- W380 X D200 X H400MM
- 內徑高度 270MM

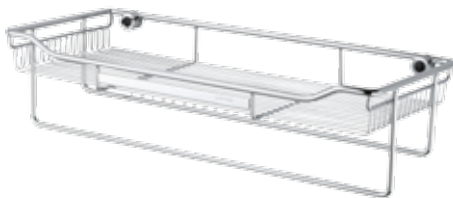

ST2298L NT\$ 4000

(實景詳見上圖)

- 毛巾及多功能架
- 附5000LC-2 掛架固定座
- TOWEL SHELF & MULTI-PURPOSE RACK
- 304 STAINLESS STEEL
- W620 X D260 X H160MM



ST2298L-2A NT\$ 4000

- 毛巾置物架-雙桿
- 附 5000SC-2 掛架固定座 厚底
- TOWEL SHELF & MULTI-PURPOSE RACK
- 304 STAINLESS STEEL
- W610 X D240 X H200MM



ST2298LD-1 NT\$ 3200

- 毛巾及多功能架-窄版-單桿
- 附 5000LC-2 掛架固定座
- TOWEL SHELF & MULTI-PURPOSE RACK
- 304 STAINLESS STEEL
- W620 X D200 X H127MM

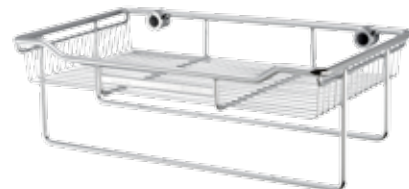

ST2298S NT\$ 3400

- 毛巾及多功能架
- 附5000LC-2 掛架固定座
- TOWEL SHELF & MULTI-PURPOSE RACK
- 304 STAINLESS STEEL
- W460 X D260 X H160MM



ST2298SH NT\$ 2850

(實景詳見頁 10)

- W460 X D260 X H65MM

ST2298LH NT\$ 3300

- W620 X D260 X H65MM

- 多功能架
- 附 5000LC-2 掛架固定座
- MULTI-PURPOSE RACK
- 304 STAINLESS STEEL



ST2298LDH NT\$ 2500

- 多功能置物架-窄版
- 附 5000LC-2 掛架固定座
- MULTI-PURPOSE RACK
- 304 STAINLESS STEEL
- W620 X D200 X H65MM



ST6678DP 扁條 NT\$ 5250

- 雙層置物架 (掛、放兩用)
- 附 5000C-2 掛架固定座 薄底
- DOUBLE RACK
- 304 STAINLESS STEEL
- W468 X D280 X H440MM
- 內徑高度 336MM



ST3078F NT\$ 5900

- 雙層置物架 (掛、放兩用)
- 附 3061-50 大滴水盤 X2
- 附 5000SC-2 掛架固定座 厚底
- DOUBLE MULTI-PURPOSE RACK
- 304 STAINLESS STEEL
- W575 X D245 X H460MM
- 內徑高度 303MM



ST3068BA NT\$ 7550

- 雙層置物架
- 附 3260C 掛桿組
- DOUBLE RACK
- 304 STAINLESS STEEL
- W625 X D250 X H620MM
- 內徑高度 220MM

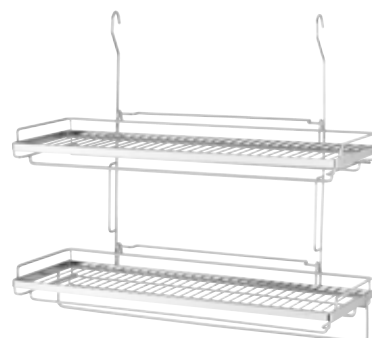

ST3068BS NT\$ 6800

- 雙層置物架
- DOUBLE RACK
- 304 STAINLESS STEEL
- W625 X D250 X H620MM
- 內徑高度 220MM



ST3033S-2CH NT\$ 3500

(實景詳見下圖)

- 雙層轉角架 (掛·放兩用)
- 附 5000C-2 掛架固定座薄底
- CORNER DOUBLE RACK
- 304 STAINLESS STEEL
- W230 X D235 X H420MM
- 內徑高度 320MM



ST3033S-3CH NT\$ 5100

- 三層轉角架 S(掛·放兩用)
- 附 5000C-2 掛架固定座底
- CORNER TRIPLE RACK
- 304 STAINLESS STEEL
- W230 X D235 X H680MM
- 內徑高度上層 240MM
- 內徑高度下層 320MM

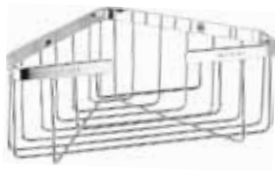

ST3209 NT\$ 1250

- 單層轉角架
- CORNER RACK
- 304 STAINLESS STEEL
- W195 X D195 X H87MM



ST3209-2 NT\$ 2550

- 雙層轉角架
- CORNER DOUBLE RACK
- 304 STAINLESS STEEL
- W195 X D195 X H348MM
- 內徑高度 270MM



ST3033SH NT\$ 2000

- W225 X D225 X H175MM

ST3033H NT\$ 2300

- W320 X D320 X H175MM
- 轉角架 - 釘式
- 附 5000SC-2 掛架固定座底
- CORNER RACK
- 304 STAINLESS STEEL



ST2296S-2H NT\$ 3400

(實景詳見右圖)

- 雙層架 (掛、放兩用)
- 附 5000SC-2 掛架固定座底
- DOUBLE RACK
- 304 STAINLESS STEEL
- W280 X D150 X H440MM
- 內徑高度 300MM



ST2296S-3H NT\$ 4950

- 三層架 (掛、放兩用)
- 附 5000SC-2 掛架固定座底
- TRIPLE RACK
- 304 STAINLESS STEEL
- W280 X D150 X H675MM
- 內徑高度上層 250MM
- 內徑高度下層 300MM



ST2295S-2H NT\$ 2700

- 小方型雙層置物架
- 附 5000SC-2 掛架固定座 厚底
- DOUBLE RACK
- 304 STAINLESS STEEL
- W225 X D152 X H350MM
- 內徑高度 230MM



ST2297-2H NT\$ 3900

- 大方型雙層置物架
- 附 5000SC-2 掛架固定座 厚底
- DOUBLE RACK
- 304 STAINLESS STEEL
- W320 X D233 X H425MM
- 內徑高度 280MM

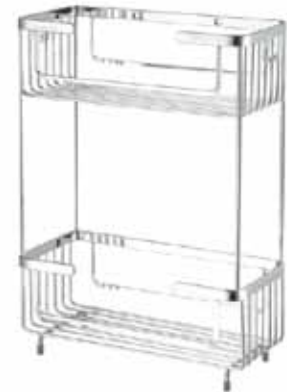

ST3208A-2 NT\$ 2700

- 雙層抽取式衛生紙架
- DOUBLE FACIAL TISSUE HOLDER
- 304 STAINLESS STEEL
- W280 X D120 X H365MM
- 內徑高度 250MM



ST3208 NT\$ 1250

- 抽取式衛生紙架
- FACIAL TISSUE BOX
- 304 STAINLESS STEEL
- W265 X D120 X H90MM

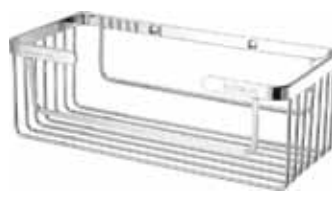

ST3208A NT\$ 1250

- 抽取式衛生紙架
- FACIAL TISSUE HOLDER
- 304 STAINLESS STEEL
- W256 X D120 X H90MM



1008T-8 NT\$ 1000

- 抽取式衛生紙盒 - 掛放兩用 - 白色
- FACIAL TISSUE BOX (ACRYLIC)
- ACRYLIC 壓克力
- W250 X D150 X H115MM (厚度 5MM)



ST2295-2H NT\$ 3600

- 方形雙層活動架 (釘式)
- 附 5000C-2 掛架固定座 薄底
- DOUBLE ACTIVE RACKS
- 304 STAINLESS STEEL
- W280 X D170 X H480MM
- 內徑高度 268MM



ST2297B-2 NT\$ 3800

- 雙層活動架
- 附 4000C-2 掛架固定座
- DOUBLE ACTIVE RACKS
- 304 STAINLESS STEEL
- W285 X D270 X H455MM
- 內徑高度 257MM



ST2297B-3 NT\$ 5100

- 三層活動架
- 附 4000C-2 掛架固定座
- TRIPLE ACTIVE RACKS
- 304 STAINLESS STEEL
- W285 X D270 X H775MM
- 內徑高度 上層 254MM
- 內徑高度 下層 306MM



ST2299-2H NT\$ 3000

- 半圓形雙層活動架 (釘式)
- 附 5000C-2 掛架固定座 薄底
- DOUBLE ACTIVE RACKS (1/2 ROUND)
- 304 STAINLESS STEEL
- W270 X D150 X H480MM
- 內徑高度 271MM



ST2299B-2 NT\$ 3200

- 半圓形雙層活動架 (掛式 - 可活動)
- 附 4000C-2 掛架固定座
- DOUBLE ACTIVE RACKS (1/2 ROUND)
- 304 STAINLESS STEEL
- W270 X D150 X H460MM
- 內徑高度 255MM



ST2299B-3 NT\$ 4500

- 半圓形三層活動架 (掛式 - 可活動)
- 附 4000C-2 掛架固定座
- TRIPLE ACTIVE RACKS (1/2 ROUND)
- 304 STAINLESS STEEL
- W270 X D150 X H775MM
- 內徑高度 上層 257MM
- 內徑高度 下層 302MM



ST2299-2 NT\$ 3350

- 半圓形淋浴拉門活動架
- SHOWER DOOR DOUBLE RACKS (1/2 ROUND)
- 304 STAINLESS STEEL
- W270 X D275 X H950MM
- 淋浴拉門厚度 65MM
- 內徑高度 311MM



ST2295-2 NT\$ 3900

- 方形淋浴拉門活動架
- SHOWER DOOR DOUBLE RACKS
- 304 STAINLESS STEEL
- W280 X D260 X H950MM
- 淋浴拉門厚度 65MM
- 內徑高度 308MM





ST2296SSH NT\$ 1650

- W280 X D175 X H95MM

ST2297SSH NT\$ 1500

- W280 X D140 X H95MM

ST2297LSH NT\$ 1700

- W320 X D145 X H95MM
- 小方形置物架
- 附5000SC-2掛架固定座 厚底
- SINGLE TRAY S
- 304 STAINLESS STEEL



ST2297LLH NT\$ 2400

- 大方形置物架
- 附 3061-30 滴水盤 X1
- 附 5000SC-2 掛架固定座 厚底
- SINGLE TRAY L
- 304 STAINLESS STEEL
- W320 X D225 X H110MM



ST2297SLH NT\$ 1900

- 大方形置物架-不附滴水盤
- 附 5000SC-2掛架固定座 厚底
- SINGLE TRAY L
- 304 STAINLESS STEEL
- W280 X D235 X H95MM



ST1008 NT\$ 1650

- 平版衛生紙架
- 附5000SC-2掛架固定座 厚底
- TOILET PAPER RACK
- 304 STAINLESS STEEL
- W235 X D217 X H95MM



ST2295SH NT\$ 1500

- 小方形置物架
- 附5000SC-2掛架固定座 厚底
- SINGLE TRAY S
- 304 STAINLESS STEEL
- W225 X D145 X H95MM



ST2299LH NT\$ 1400

- 半圓置物架
- 附 5000SC-2掛架固定座 厚底
- SINGLE TRAY
- 304 STAINLESS STEEL
- W270 X D150 X H100MM



ST3205 NT\$ 700

- 面紙架 (釘式)
- FACIAL TISSUE HOLDER
- 304 STAINLESS STEEL
- W135 X D105 X H195MM



ST3205T NT\$ 900

- 面紙架 (釘式) 可橫、直用
- FACIAL TISSUE HOLDER
- 304 STAINLESS STEEL
- W150 X D125 X H235MM

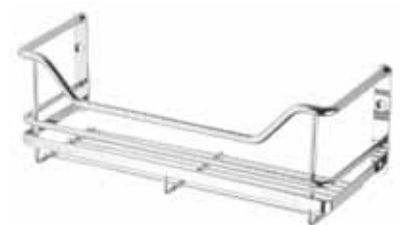

ST5230A NT\$ 1350

- 衛生紙架(單瓶架)
- 可浴櫃內用
- FACIAL TISSUE HOLDER
- 304 STAINLESS STEEL
- W310 X D110 X H115MM

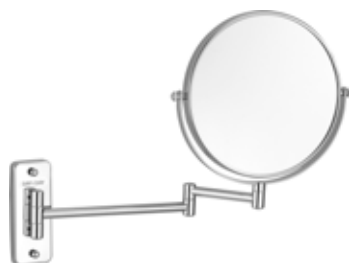

STA0010

NT\$ 3300

(實景詳見左圖)

- 壁掛式雙面伸縮鏡
- 304 不鏽鋼
- REVERSIBLE WALL-EXTENSION MIRROR
- 304 STAINLESS STEEL
- 鏡面 Ø180MM
- 底座 W48 X H125MM
- 伸縮長度：
一段 215MM / 二段 305MM
- 平面·放大 (放大三倍)



1006LC

NT\$ 2500

- 桌上型雙面明鏡
- 平面·放大 (放大兩倍)
- 鏡面 Ø190MM
- PORTABLE 2-SIDE MIRROR
- CHROME PLATING 不鏽鋼色
- BRASS 青銅材質
- W270 X D130 X H350MM



2005BD

NT\$ 470

- 吹風機架 (小)
- BLOWER HOLDER
- CHROME PLATING 不鏽鋼色
- 圓內徑 60MM



2002BF

NT\$ 600

- 吹風機架 (大)
- BLOWER HOLDER
- CHROME PLATING 不鏽鋼色
- 圓內徑 95MM



STA0003

NT\$ 1200

- 吹風機架
- 適用負離子吹風機
- HAIR DRYER HOLDER
- 304 STAINLESS STEEL
- W93 X D135 X H60MM
- 圓內徑 86MM



ST3207T

NT\$ 450

- 肥皂架 掛、放兩用
- SOAP HOLDER
- 304 STAINLESS STEEL
- W140 X D90 X H20MM



ST3207

NT\$ 370

- 肥皂架 (桌上型)
- SOAP HOLDER
- 304 STAINLESS STEEL
- W140 X D90 X H20MM



ST6632

NT\$ 1900

(實景詳見下圖)

- 多功能盥洗架
- 附壓克力牙刷杯X2 壓克力香皂盤X1
- 可另選購7000C-2 或 7200C-2 螺絲固定座
- MULTI-FUNCTION TUMBLER HOLDER
- 304 STAINLESS STEEL
- W310 X D170 X H142MM



ST6632A-2

NT\$ 1600

- 多功能盥洗架組
- 附活動式杯架X2
- 可另選購香皂盤(3506A)
- MULTI-FUNCTION BRUSH HOLDER
- 304 STAINLESS STEEL
- W298 X D150 X H120MM



2006GA

NT\$ 180

- 壓克力皂盤
- SOAP DISH
- ACRYLIC



2005GA

NT\$ 100

- 壓克力牙刷杯
- TOOTH-BRUSH CUP
- ACRYLIC



ST6632A

NT\$ 950

- 小型多功能盥洗架 S
- MULTI-FUNCTION BRUSH HOLDER S
- 304 STAINLESS STEEL
- W125 X D150 X H120MM



STA0002

NT\$ 900

- 香皂盤架
- 304 不鏽鋼
- 附透明玻璃香皂盤 GLASS SOAP
- SOAP DISH WITH HOLDER
- 304 STAINLESS STEEL
- W110 X D130 X H68MM



STA0001

NT\$ 900

- 牙刷杯架
- 304 不鏽鋼
- 附透明玻璃杯 GLASS CUP
- TUMBLER CUP WITH HOLDER
- 304 STAINLESS STEEL
- W67 X D110 X H100MM



ST6632B

NT\$ 350

- 活動式杯架
- ACTIVE CUP RACK
- 304 STAINLESS STEEL
- W90 X D90 X H35MM



1024

NT\$ 180

- 透明玻璃 香皂盤
- SOAP DISH
- GLASS
- Ø110 X H40MM



1023

NT\$ 130

- 透明玻璃牙刷杯
- TOOTH-BRUSH CUP
- GLASS
- Ø70X H95MM



**STA0007**

NT\$ 800

- 單掛衣勾
- 304 不鏽鋼
- SINGLE ROBE HOOK
- 304 STAINLESS STEEL
- W60 X D57 X H60MM

**STA0008**

NT\$ 900

- 雙掛衣勾
- 304 不鏽鋼
- DOUBLE ROBE HOOK
- 304 STAINLESS STEEL
- W90 X D70 X H60MM

**STA0009**

NT\$ 1800

- 手機及捲筒衛生紙架
- 304 不鏽鋼
- PAPER ROLL & PHONE
- HOLDER
- 304 STAINLESS STEEL
- W185 X D118 X H78MM

**2003CC**

NT\$ 1100

- 捲筒衛生紙架
- 蓋子為 304 不鏽鋼鏡面拋光
- PAPER HOLDER WITH LID
- 304 STAINLESS STEEL
- CHROME PLATING 不鏽鋼色
- W160 X D65 X H109MM

**2303-01**

NT\$ 1100

- 捲筒衛生紙架(有蓋)
- 蓋子為 304 不鏽鋼鏡面拋光
- PAPER HOLDER WITH LID
- 304 STAINLESS STEEL
- CHROME PLATING 不鏽鋼色
- W168 X D70 X H110MM

**2003C**

NT\$ 780

- 捲筒衛生紙架(毛巾架)
- PAPER ROLL HOLDER
- (TOWEL HOLDER)
- CHROME PLATING 不鏽鋼色
- W160 X D65 X H100MM

**STA0011**

NT\$ 1000

- 浴巾架
- 304 不鏽鋼
- BIGGER TOWER RING
- 304 STAINLESS STEEL
- W170 X D67 X H195MM
- 圓內徑 : 145MM

**2001C**

NT\$ 750

- (實景詳見頁 24)
- 毛巾環
- TOWEL RING
- CHROME PLATING
- 不鏽鋼色
- W160 X D65 X H180MM
- 圓內徑 140MM

**1010C**

NT\$ 480

- 浴巾環
- BIGGER TOWEL RING
- CHROME PLATING
- 不鏽鋼色
- W170 X D60 X H175MM
- 圓內徑 145MM

**3100C**

NT\$ 480

- 浴巾環
- BIGGER TOWEL RING
- CHROME PLATING
- 不鏽鋼色
- W170 X D60 X H195MM
- 圓內徑 145MM



STA0005 NT\$ 1350

- 馬桶刷架
- 304 不鏽鋼
- 附霧面玻璃杯 & 馬桶刷
- TOILET BRUSH & GLASS CUP WITH HOLDER
- 304 STAINLESS STEEL
- W112 X D132 X H345MM
- 圓內徑 86MM



STA0006 NT\$ 150

- 馬桶刷
- 304 不鏽鋼
- TOILET BRUSH
- 304 STAINLESS STEEL
- W335MM



1025 NT\$ 250

- 霧面玻璃 馬桶刷杯
- TOILET BRUSH CUP
- GLASS
- Ø115 X H112MM



2002BC NT\$ 1420

- 馬桶刷架
- 青銅固定座
- 附馬桶刷 & 瓷杯
- TOILET BRUSH & PORCELAIN CUP WITH BRASS HOLDER
- W122 X D152 X H400MM
- 圓內徑 95MM



2002BD NT\$1100

- 馬桶刷架
- 青銅固定座
- 附馬桶刷 & 玻璃杯
- TOILET BRUSH & GLASS CUP WITH BRASS HOLDER
- W123 X D151 X H420MM
- 圓內徑 95MM



2002CB NT\$ 250

- 馬桶刷
- TOILET BRUSH
- CHROME PLATING 不鏽鋼色
- W390MM



2002GC NT\$ 600

- 馬桶刷杯
- TOILET BRUSH CUP
- 瓷器 PROCELAIN
- 有排水孔



2002G NT\$ 250

- 馬桶刷杯
- TOILET BRUSH CUP
- 玻璃 GLASS
- 有排水孔



雙層旋轉直立架



6650-01 NT\$ 5500

- CHROME PLATING 不鏽鋼色
- 桿子 H480MM
- 6691-1方型置物架(大)2個
HOLDER L (RECTANGLE SHAPE)
304 STAINLESS STEEL
W280 X D140 X H60 MM



6656C NT\$ 5400

- CHROME PLATING 不鏽鋼色
- 桿子H480MM
- 6691-1 方型置物架(大)
HOLDER L (RECTANGLE SHAPE)
304 STAINLESS STEEL
W280 X D140 X H60MM
- 6691-2 方型置物架(小)
HOLDER S (RECTANGLE SHAPE)
304 STAINLESS STEEL
W225 X D140 X H60MM



6650-02 NT\$ 5310

- CHROME PLATING 不鏽鋼色
- 桿子 H480MM
- 6691-1方型置物架(大)
HOLDER L (RECTANGLE SHAPE)
304 STAINLESS STEEL
W280 X D140 X H60 MM
- 6691-3圓形置物架
HOLDER S (ROUND SHAPE)
304 STAINLESS STEEL
Ø178 X H60MM



6650-03 NT\$ 4850

- CHROME PLATING 不鏽鋼色
- 桿子 H480MM
- 6691-1 方型置物架 (大)
HOLDER L (RECTANGLE SHAPE)
304 STAINLESS STEEL
W280 X D140 X H60MM
- 6670-2C 毛巾環架
SMALL TOWEL RING
Ø160MM 圓內徑 140MM



6650-07 NT\$ 5010

- CHROME PLATING 不鏽鋼色
- 桿子 H480MM
- 6691-3 圓形置物架
HOLDER S (ROUND SHAPE)
304 STAINLESS STEEL
Ø178 X H60MM
- 6670-1C 衛生紙架 (有蓋)
TOILET PAPER HOLDER WITH LID
W165 X D110MM



6650-08 NT\$ 5200

- CHROME PLATING 不鏽鋼色
- 桿子 H480MM
- 6691-1 方型置物架 (大)
HOLDER L (RECTANGLE SHAPE)
304 STAINLESS STEEL
W280 X D140 X H60MM
- 6670-1C 衛生紙架 (有蓋)
TOILET PAPER HOLDER WITH LID
W165 X D110MM

三層旋轉直立架



6670-01 NT\$ 7160

- CHROME PLATING 不鏽鋼色
- 桿子 H695MM
- 6691-1方型置物架(大)
HOLDER L (RECTANGLE SHAPE)
304 STAINLESS STEEL
W280 X D140 X H60 MM
- 6691-2方型置物架(小)
HOLDER S (RECTANGLE SHAPE)
304 STAINLESS STEEL
W225 X D140 X H60 MM
- 6691-3圓形置物架
HOLDER S (ROUND SHAPE)
304 STAINLESS STEEL
Ø178 X H60 MM



6670-07 NT\$ 7050

- CHROME PLATING 不鏽鋼色
- 桿子 H695MM
- 6691-1 方型置物架 (大)
HOLDER (RECTANGLE SHAPE)
304 STAINLESS STEEL
W280 X D140 X H60MM
- 6691-2 方型置物架 (小)
HOLDER S (RECTANGLE SHAPE)
304 STAINLESS STEEL
W225 X D140 X H60MM
- 6670-1C 衛生紙架 (有蓋)
TOILET PAPER HOLDER WITH LID
W165 X D110MM



6670-03 NT\$ 7260

- CHROME PLATING 不鏽鋼色
- 桿子 H695MM
- 6691-1方型置物架(大)2個
HOLDER L (RECTANGLE SHAPE)
304 STAINLESS STEEL
W280 X D140 X H60 MM
- 6691-3圓形置物架
HOLDER S (ROUND SHAPE)
304 STAINLESS STEEL
Ø178 X H60 MM



6670-08 NT\$ 6800

- CHROME PLATING 不鏽鋼色
- 桿子 H695MM
- 6691-1 方型置物架 (大) 2 個
HOLDER (RECTANGLE SHAPE)
304 STAINLESS STEEL
W280 X D140 X H60MM
- 6670-2C 毛巾環架
TWOEL RING
Ø160MM 圓內徑 140MM



6670-05 NT\$ 7450

- CHROME PLATING 不鏽鋼色
- 桿子 H695MM
- 6691-1 方型置物架 (大) 3 個
HOLDER (RECTANGLE SHAPE)
304 STAINLESS STEEL
W280 X D140 X H60MM



6670-09 NT\$ 6610

- CHROME PLATING 不鏽鋼色
- 桿子 H695MM
- 6691-1 方型置物架 (大)
HOLDER (RECTANGLE SHAPE)
304 STAINLESS STEEL
W280 X D140 X H60MM
- 6691-3 圓形置物架
HOLDER S (ROUND SHAPE)
304 STAINLESS STEEL
Ø178 X H60MM
- 6670-2C 毛巾環架
TWOEL RING
Ø160MM 圓內徑 140MM

採用新一代無鉛無銅無毒製程

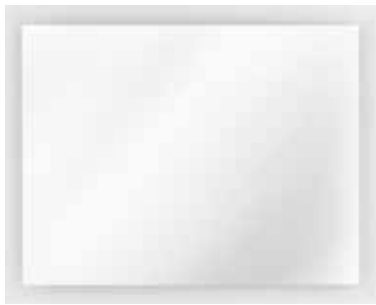

M-H919 NT\$ 13500

(實景詳見頁 29)

- LED 防霧鏡
- 橫掛
- 開關：右下揮手
- W800 X H600MM



M-H716 NT\$ 12500

(實景詳見頁 28 右下)

- LED 防霧鏡
- 橫掛
- 開關：右下觸碰
- W800 X H600MM



M-H720 NT\$ 12000

- LED 噴砂防霧鏡 + 時間
- 直掛
- 開關：右下揮手
- W500 X H700MM

易潔鏡專區

易潔鏡特色

採用特定奈米鍍模塗層，水氣不易凝結。

髒污、水漬不易附著於鏡子表面，鏡面用清水即可清潔。



NEW

M-1527 NT\$ 5900

- 雙層易潔鏡 (可橫、直掛)
- MIRROR
- W480 X H680MM



M-1023B NT\$ 8000

- 長方形易潔鏡 (可橫、直掛)
- 黑色 鋁框
- W600 X H800MM



M-1026B NT\$ 8700

- 圓形易潔鏡 黑色
- 鋁框
- MIRROR
- Ø585MM



M-122 NT\$ 3300

- W600 X H450MM

M-122L NT\$ 5200

- W800 X H600MM
- 長方形易潔鏡 (可橫、直掛)
- MIRROR

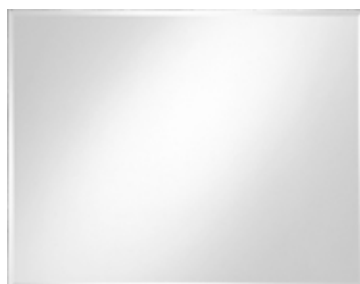

M-1528 NT\$ 4600

(實景詳見頁 21)

- 鑽雕易潔鏡 (可橫、直掛)
- MIRROR
- W700 X H500MM



M-H920 NT\$ 13500
(實景詳見頁 27)

- LED 防霧鏡
- 直掛
- MIRROR
- W500 X H700MM

NEW



防霧鍵開關

ON 為白光 ; OFF 為藍光



燈源鍵

短按：三段光源

白光、黃光、暖白光

長按：調整光線亮度



M-1006 NT\$ 3000

- 橢圓形防霧鏡
- MIRROR
- W480 X H680MM



M-1005 NT\$ 3000

- 長方形防霧鏡 (可橫、直掛)
- MIRROR
- W680 X H480MM



6008G W560 X H600MM NT\$ 3400

6008GL W800 X H600MM NT\$ 4200

- 方形防霧鏡 (可橫、直掛)
- MIRROR



8008G NT\$ 3700

- 圓形防霧鏡
- MIRROR
- φ 585MM

符合台灣 CNS、日本 JIS R3202、歐盟 ROHS、北美 ASTM 檢驗標準。經 CASS Test (ASTM B368) 480hrs 實驗證實，更具耐腐蝕性與耐候性。使用台玻電子級專用玻璃製鏡。

產品優點：

抗化學性耐腐蝕性能，為傳統一般鏡 4 倍以上。
無鉛無銅無毒製程，符合環保訴求。
為世界未來發展主流趨勢是綠色環保裝飾建材新選擇。

鏡子清潔保養方式：

使用後請關掉電源。
請先以濕布擦鏡子，然後用乾布將鏡面水份擦淨，可讓鏡面潔淨。
請勿以強酸、強鹼清潔劑清洗鏡面。
請勿用水沖洗鏡面及開關。





3507 NT\$ 1650

- 鏡子平台架
- 附 3500-2 固定座 / 一對
- 10MM GLASS SHELF WITH 3500-2 HOLDER
- 10MM 霧面強化玻璃
- W600 X D145MM



3500-2 NT\$ 900/ 一對

- 固定座 / 一對 HOLDER
- CHROME PLATING 不鏽鋼色
- BRASS 青銅材質
- 可夾玻璃最大厚度 10MM
- W50 X D25 X H26MM



3508MCG NT\$ 1500

- W400 X D146MM

3508CG NT\$ 1750

- W600 X D146MM

3508CGL NT\$ 2000

- W800 X D146MM
- 鏡子平台架
- 附 3500-2 固定座 / 一對
- 10MM GLASS SHELF WITH 3500-2 HOLDER
- 10MM OG 邊強化玻璃



3517 NT\$ 2300 (實景詳見上圖)

- 霧面玻璃平台架 - 附圍欄
- 附 3500-2 固定座 / 一對
- 10MM GLASS SHELF WITH RAIL & 3500-2 HOLDER
- 10MM 霧面強化玻璃
- W600 X D150MM

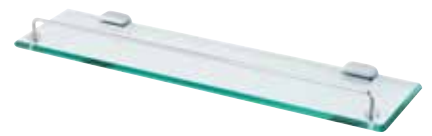

3509LFG NT\$ 2200

- 鏡子平台架 附圍欄
- 附 3500-2 固定座 / 一對
- 10MM GLASS SHELF WITH 3500-2 HOLDER
- 10MM OG 邊強化玻璃
- W600XD146MM



3523MK NT\$ 1750

- 轉角架 - 附圍欄
- 附 3500-2 固定座一對
- 8MM GLASS CORNER HOLDER WITH 3500-2 HOLDER
- 8MM OG 邊強化玻璃
- W250 X D250MM



3512MFG NT\$ 1850

- 轉角架 - 附圍欄
- 附 3500-2 固定座 / 一對
- 8MM GLASS CORNER HOLDER WITH 3500-2 HOLDER
- 8MM OG 邊強化玻璃
- W250 X D250MM



3511CG NT\$ 1600

- 轉角架
- 附 3500-2 固定座 / 一對
- 10MM GLASS CORNER HOLDER WITH 3500-2 HOLDER
- 10MM OG 邊強化玻璃
- W280 X D280MM



STH3700-2 NT\$ 1500/ 一對

- 固定座 / 一對 HOLDER
- 304 不鏽鋼鏡面拋光
- 304 STAINLESS STEEL
- 可夾玻璃最大厚度 10MM
- W50 X D35 X H21MM



STH3707 NT\$ 2250

- 鏡子平台架
- 附 STH3700-2 固定座 / 一對
- 10MM GLASS SHELF WITH STH3700-2 HOLDER
- 10MM 霧面強化玻璃
- W600 X D145MM

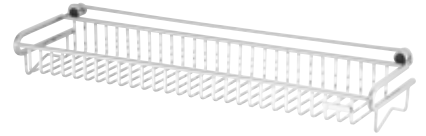

ST3268XL NT\$ 3050

- 平台置物架
- 附 5000SC-2 掛架固座 厚底
- MIRROR RACK
- 304 STAINLESS STEEL
- W600 X D160 X D90MM



STH3708MCG NT\$ 2100

- W400 X D146MM

STH3708CG NT\$ 2350

- W600 X D146MM

STH3708CGL NT\$ 2600

- W800 X D146MM
- 鏡子平台架
- 附 STH3700-2 固定座 / 一對
- 10MM GLASS SHELF WITH STH3700-2 HOLDER
- 10MM OG 邊強化玻璃



STH3717 NT\$ 2900

- 霧面玻璃平台架 - 附圍欄
- 附 STH3700-2 固定座 / 一對
- 10MM GLASS SHELF WITH RAIL & STH3700-2 HOLDER
- 10MM 霧面強化玻璃
- W600 X D150MM



STH3709LFG NT\$ 2800

- 鏡子平台架 附圍欄
- 附 STH3700-2 固定座 / 一對
- 10MM GLASS SHELF WITH STH3700-2 HOLDER
- 10MM OG 邊強化玻璃
- W600XD146MM



2217 NT\$ 650

- 平台圍欄組
- RAIL FOR GLASS SHELF
- 304 STAINLESS STEEL
- W551 X H36MM



STH3723MK NT\$ 2350

- 轉角架 - 附圍欄
- 附 STH3700-2 固定座一對
- 8MM GLASS CORNER HOLDER WITH STH3700-2 HOLDER
- 8MM OG 邊強化玻璃
- W250 X D250MM



STH3712MFG NT\$ 2450

- 轉角架 - 附圍欄
- 附 STH3700-2 固定座 / 一對
- 8MM GLASS CORNER HOLDER WITH STH3700-2 HOLDER
- 8MM OG 邊強化玻璃
- W250 X D250MM



STH3711CG NT\$ 2200

- 轉角架
- 附 STH3700-2 固定座 / 一對
- 10MM GLASS CORNER HOLDER WITH STH3700-2 HOLDER
- 10MM OG 邊強化玻璃
- W280 X D280MM



ST3015H

NT\$ 2400

(實景詳見頁 32)

- 刀柄砧板架 掛式
- 附 3061-25 滴水盤 X1
- KNIFE & CARVING BOARD HOLDER
- 304 STAINLESS STEEL
- W250 X D170 X H458MM
- 砧板厚度 45MM



ST3015C

NT\$ 1550

- 刀柄架 掛式
- KNIFE HOLEDR
- 304 STAINLESS STEEL
- W250 X D90 X H415MM



ST3215T NT\$ 1800 (實景詳見頁 36)

- 桌上型刀柄砧板架
- 附 3061-25L 滴水盤 X1
- KNIFE CARVING BOARD STAND
- 304 STAINLESS STEEL
- W290 X D165 X H255MM
- 砧板厚度 35 / 20MM



ST3215-1 NT\$ 1700

- 桌上型刀柄砧板架 (單層砧板架)
- 附 3061-25L 滴水盤 X1
- KNIFE CARVING BOARD STAND
- 304 STAINLESS STEEL
- W290 X D165 X H255MM
- 砧板厚度 50MM



ST3015ST-01 NT\$ 1150

- 刀柄架 門板釘式
- 可加購 5000C-2 掛架固定座
- KNIFE HOLDER
- 304 STAINLESS STEEL
- W245 X D60 X H265MM



ST3215L NT\$ 2100

- 桌上型 刀柄 砧板 鍋蓋架
- 附 3061-30 滴水盤 X 1
- KNIFE & CARVING BOARD & LID STAND
- 304 STAINLESS STEEL
- W300 X D230 X H 255MM
- 鍋蓋深度 83MM
- 砧板厚度 43MM



ST3015F NT\$ 2700

- 刀柄 砧板 鍋蓋架 掛式
- 附 3061-25 滴水盤 X 1
- KNIFE & CARVING BOARD & LID HOLDER
- 304 STAINLESS STEEL
- W257 X D187 X H443MM
- 鍋蓋深度 78MM
- 砧板厚度 43MM



NEW

ST3015K NT\$ 2200

- 刀柄砧板架 掛式
- 附 3061-20 滴水盤 X 1
- KNIFE & CARVING BOARD HOLDER
- 304 STAINLESS STEEL
- W205 X D160 X H460MM
- 砧板寬度 30 / 25MM



ST3215TS NT\$ 2000 (實景詳見頁 31)

- 桌上型刀柄砧板架
- 附 3061-20 滴水盤 X1
- KNIFE CARVING BOARD STAND
- 304 STAINLESS STEEL
- W185 X D150 X H235MM
- 砧板厚度 30MM



ST3015T NT\$ 1350

- 桌上型刀柄鍋蓋架
- 附 3061-20 滴水盤 X1
- KNIFE & LID STAND
- 304 STAINLESS STEEL
- W203 X D142 X H235MM



ST3023F NT\$ 2750

- 雙層調味罐架 掛式
- 可放保鮮膜、調味罐
- SPICE RACK
- 304 STAINLESS STEEL
- W300 X D192 X H360MM
- 內徑高度 140MM



ST3030L NT\$ 2000

- 調味罐架
- 可放保鮮膜、調味罐
- SPICE RACK
- 304 STAINLESS STEEL
- W350 X D180 X H275MM
- 內徑高度 125MM

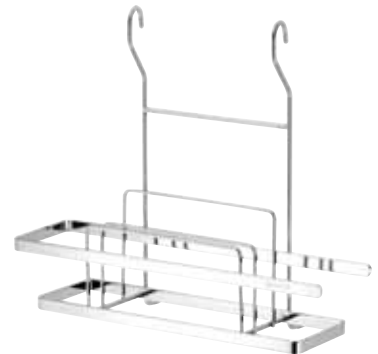

ST3026C NT\$ 2350

- 砧板架 掛式
- CARVING BOARD RACK
- 304 STAINLESS STEEL
- W405 X D145 X H350MM
- 砧板厚度 23 / 30 / 30MM



ST3023H NT\$ 3100

- 桌上型雙層調味架
- 附 3061-25L 滴水盤 X1
- 附 5000SC-2 掛架固定座 厚底
- DOUBLE SPICE RACKS
- 304 STAINLESS STEEL
- W300 X D178 X H307MM
- 內徑高度 170MM





ST3088AH NT\$ 1650

- 單層活動架
- 附 5000SC-2 掛架固定座 厚底
- SINGLE ACTIVE RACK
- 304 STAINLESS STEEL
- W335 X D145 X H93MM



ST3088BH NT\$ 1600

- 單層調味架
- 附5000SC-2掛架固定座 厚底
- SINGLE SPICE RACK
- 304 STAINLESS STEEL
- W335 X D145 X H93MM



NEW

ST3088-2 NT\$ 3250

- 雙層活動式調味架
- DOUBLE SPICE ACTIVE RACKS
- 304 STAINLESS STEEL
- W335 X D175 X H470MM
- 內徑高度 250MM



ST3088A NT\$ 1950

- 單層活動架
- SINGLE ACTIVE RACK
- 304 STAINLESS STEEL
- W335 X D155 X H285MM



ST3088B NT\$ 1900

- 單層調味架
- SINGLE SPICE RACK
- 304 STAINLESS STEEL
- W335 X D155 X H285MM



NEW

ST3088F-2 NT\$ 3250

- 冰箱雙層活動式調味架
- DOUBLE SPICE ACTIVE RACKS FOR REFRIGERATOR
- 304 STAINLESS STEEL
- W335 X D202 X H445MM
- 內徑高度 290MM



ST2297L NT\$ 4350

- 雙層活動掛架
- 附 3061-30 滴水盤 X1
- DOUBLE ACTIVE RACK W / PLATE
- 304 STAINLESS STEEL
- W320 X D250 X H455MM
- 內徑高度 232MM





ST3020 NT\$ 2350

- 多用途掛架 長勾
- MULTI-PURPOSE RACK
- 304 STAINLESS STEEL
- W455 X D185 X H330MM

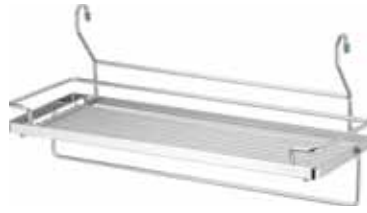

ST3020S NT\$ 2150

- 多用途掛架 短勾
- MULTI-PURPOSE RACK
- 304 STAINLESS STEEL
- W455 X D185 X H210MM



ST3028C NT\$ 3000 (實景詳見下圖)

- 調味罐及瓶罐架
- SPICE WITH BOTTLE RACK
- 304 STAINLESS STEEL
- W400 X D200 X H360MM



ST3029-01 NT\$ 1800

(實景詳見頁 33)

- 桌上型雙層調理罐架
- DOUBLE SPICE RACKS
- 304 STAINLESS STEEL
- W305 X D105 X H280MM
- 內徑高度 156MM

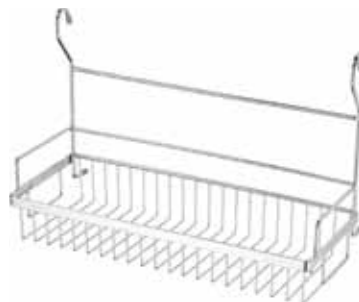

ST3029 NT\$ 2300

- 瓶罐架
- BOTTLE RACK
- 304 STAINLESS STEEL
- W450 X D210 X H300MM



ST3028 NT\$ 2750

- 調味罐及瓶罐架
- SPICE WITH BOTTLE RACK
- 304 STAINLESS STEEL
- W345 X D230 X H355MM





ST3023 NT\$ 2600

- 調味罐及紙巾架
- SPICE WITH PAPER TOWEL HOLDER
- 304 STAINLESS STEEL
- W300 X D195 X H355MM



ST3023C NT\$ 2300

- 調味罐及紙巾架
- SPICE WITH PAPER TOWEL HOLDER
- 304 STAINLESS STEEL
- W330 X D140 X H300MM

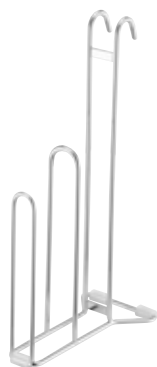

ST2003D NT\$ 850
(實景詳見上圖)

- 紙巾架
- 掛式及桌上型兩用
- PAPER TOWEL HOLDER
- 304 STAINLESS STEEL
- W95 X D176 X H310MM

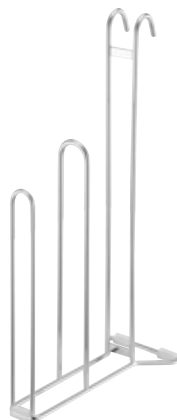

ST2003DL NT\$ 950

- 紙巾架-大型紙巾適用
- 掛式及桌上型兩用
- PAPER TOWEL HOLDER
- 304 STAINLESS STEEL
- W95 X D213 X H380MM

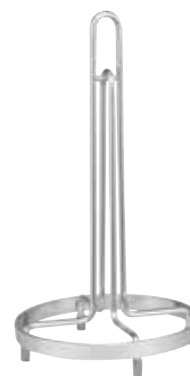

NEW

ST2003HB NT\$ 1100

- 桌上型紙巾架
- PAPER TOWEL STAND
- 304 STAINLESS STEEL
- 直徑 Ø162XH300MM



ST3006K NT\$ 800

- 隔熱墊
- HOT MAT
- 304 STAINLESS STEEL
- W238 X D200 X H15MM



ST3006F NT\$ 700
(實景詳見頁 43)

- 花型隔熱墊
- FLOWER SHAPE HOT MAT
- 304 STAINLESS STEEL
- φ 240MM



ST3006L NT\$ 450

- φ 205MM

ST3006S NT\$ 390

- φ 180MM
- 隔熱墊
- HOT MAT
- 304 STAINLESS STEEL



ST3027B NT\$ 1000

(實景詳見頁下圖)

- 鍋蓋架 掛式 附集水盒
- LID HOLDER WITH A BOX
- 304 STAINLESS STEEL
- W205 X D140 X H455MM



ST3027C NT\$ 1050

- 鍋蓋架 釘式 附集水盒
- 附5000C-2掛架固定座 薄底
- LID HOLDER WITH A BOX
- 304 STAINLESS STEEL
- W205 X D140 X H415MM



ST3027F NT\$ 1250

- 鍋蓋砧板架-掛式 附集水盒
- LID & CARVING BOARD HOLDER
- 304 STAINLESS STEEL
- W205 X D160 X H470MM



3027P NT\$ 70

- 集水盒
- 適用 ST3027C、ST3027B、ST3027F



ST3027-01 NT\$ 1350

- 桌上型鍋蓋砧板架
- 附 3061-25 滴水盤 X1
- LID & CARVING BOARD HOLDER
- 304 STAINLESS STEEL
- W255 X D170 X H190MM
- 砧板厚度 30 / 25MM
- 鍋蓋深度 58MM



ST3031 NT\$ 1500

- 桌上型平底鍋架 附滴水盤
- 附 3061-30 滴水盤 X 1
- SAUCEPAN STAND
- 304 STAINLESS STEEL
- W318 X D230 X H194MM



ST3027T NT\$ 1800

- 桌上型鍋蓋架
- 附 3061-25 滴水盤 X1
- LID STAND
- 304 STAINLESS STEEL
- W255 X D170 X H420MM



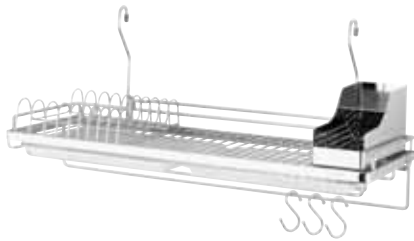

ST3068S-01 NT\$ 6200

- 碗盤架
- 附 3061-30 滴水盤 X2
- ST3003-01 餐具桶、插盤架、單 S 掛勾 X 3
- BOWL AND DISHES RACK WITHOUT TUBE & HOLDER
- 304 STAINLESS STEEL
- W640 X D250 X H290MM

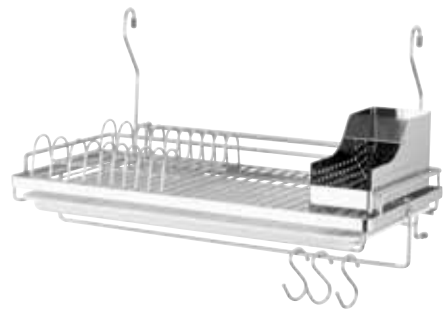

ST3078S-01 NT\$ 5650

- 碗盤架 - 掛式
- 附 3061-50 滴水盤 X1
- ST3003-01 餐具桶、插盤架、單 S 掛勾 X 3
- BOWL AND DISHES RACK WITHOUT TUBE & HOLDER
- 304 STAINLESS STEEL
- W502 X D280 X H290MM



ST3078D-01 NT\$ 8300

- 雙層置物架
- 附 3061-50 滴水盤 X2
- 附 5000SC-2 掛架固定座 厚底
- ST3003-01 餐具桶、插盤架、單 S 掛勾 X3
- DOUBLE MULTI-PURPOSE RACK
- 304 STAINLESS STEEL
- W575 X D245 X H460MM
- 內徑高度 303MM



ST2297A NT\$ 2650

- 小型碗盤架
- 附 3061-30 滴水盤 X1
- SMALL BOWL AND DISHES RACK
- 304 STAINLESS STEEL
- W320 X D255 X H285MM



ST3078F NT\$ 5900

- 雙層置物架 (掛、放兩用)
- 附 3061-50 大滴水盤 X2
- 附 5000SC-2 掛架固定座 厚底
- DOUBLE MULTI-PURPOSE RACK
- 304 STAINLESS STEEL
- W575 X D245 X H460MM
- 內徑高度 303MM



ST6678DP-01 NT\$ 5500

- 雙層置物架 (扁條)
- 附 5000C-2 掛架固定座 薄底
- 附 ST6678A 瓶罐架
- DOUBLE MULTI-PURPOSE RACK
- 304 STAINLESS STEEL
- W468 X D280 X H440MM



ST2298D-01 NT\$ 5950

- 碗盤架
- 附 3061-30 滴水盤 X2
- 附 5000LC-2 掛架固定座
ST3003-01 餐具桶、插盤架
- BOWL AND DISHES RACK
WITH 5000LC-2 HOLDER
- 304 STAINLESS STEEL
- W620 X D260 X H90MM

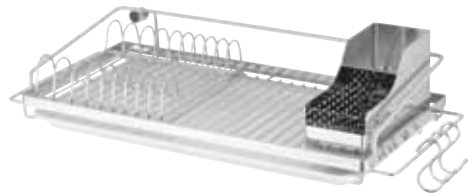

ST3078A-01 NT\$ 5050

- 碗盤架 - 釘式
- 附 3061-50 滴水盤 X1
- 附 5000SC-2 掛架固定座 厚底
ST3003-01 餐具桶、插盤架、
單 S 掛勾 X 3
- SINGLE MULTI-PURPOSE RACK
WITH 5000SC-2 HOLDER
- 304 STAINLESS STEEL
- W575 X D245 X H100MM

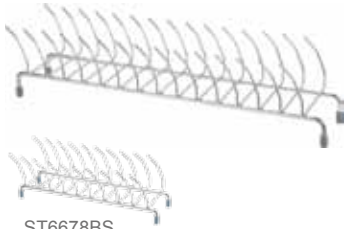

ST6678BS

ST6678B NT\$ 750

- 14 格
- W400 X D90 X H100MM

ST6678BS NT\$ 600

- 9 格
- W270 X D90 X H90MM
- 碗盤架
- DISHES HOLDER
- 304 STAINLESS STEEL



ST3078 NT\$ 2650

- 單層置物架
- 附 3061-50 滴水盤 X1
- 附 5000SC-2 掛架固定座 厚底
- SINGLE MULTI-PURPOSE RACK
WITH 5000SC-2 HOLDER
- 304 STAINLESS STEEL
- W575 X D245 X H100MM

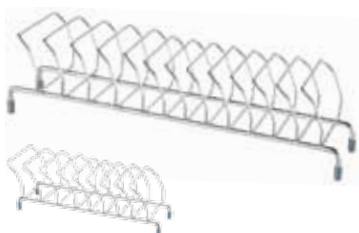

ST6678CS

ST6678C NT\$ 950

- 12 格
- W400 X D90 X H105MM

ST6678CS NT\$ 700

- 8 格
- W265 X D90 X H98MM
- 盤子架
- DISHES HOLDER
- 304 STAINLESS STEEL



NEW



ST3060-01 NT\$ 950

- 碗架
- BOWL HOLDER
- 304 STAINLESS STEEL
- Ø 150 X H195MM

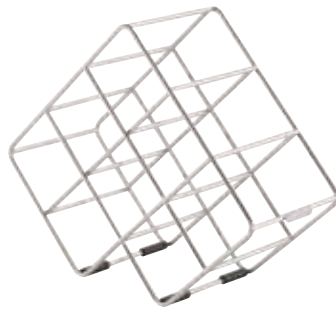

ST3055 NT\$ 2300

- (實景詳見右圖)
- 紅酒架
 - WINE HOLDER
 - 304 STAINLESS STEEL
 - W356 X D295 X H150MM



ST3060D NT\$ 1600

- (實景詳見頁 40)
- 桌上型碗盤架
 - 附 3061-30 滴水盤 X1
 - DISHES HOLDER W/PLATE
 - 304 STAINLESS STEEL
 - W323 X D210 X H105MM



ST3060L NT\$ 1150

- 桌上型盤子架
- 附 3061-30 滴水盤 X1
- DISHES HOLDER
- 304 STAINLESS STEEL
- W312 X D226 X H110MM

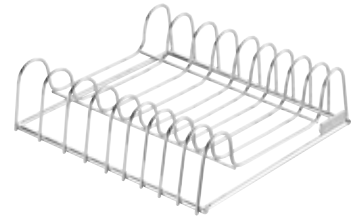

ST3060 NT\$ 800

- 盤子架 可拉籃內用
- DISHES HOLDER
- 304 STAINLESS STEEL
- W205 X D205 X H60MM



ST3008D-2 NT\$ 3250

- 桌上型雙層碗盤架
- 附 3061-30 滴水盤 X2
- DOUBLE MULTI-PURPOSE RACK
- 304 STAINLESS STEEL
- W350 X D230 X H315MM
- 內徑高度 220MM



ST3008D NT\$ 2150

- 桌上型置物盤
- 附 3061-30 滴水盤 X1
- DISHES HOLDER W/PLATE
- 304 STAINLESS STEEL
- W350 X D245 X H110MM



ST3008 NT\$ 2050

- 桌上型水果盤
- 附 3061-30 滴水盤 X1
- FRUIT HOLDER
- 304 STAINLESS STEEL
- W355 X D250 X H150MM

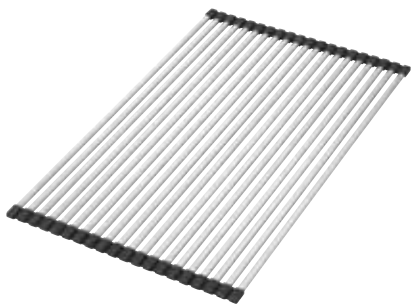

ST3052 NT\$ 3900

- 全展 W316 X D506MM
- 收納 Ø53 X D506MM
- 適用四方型水槽



- 滴水捲簾
- ROLLABLE DISHES HOLDER
- 304 STAINLESS STEEL
- 食用級耐熱矽膠
- 20 支 304 不鏽鋼扁條



ST3052L NT\$ 4350

- 全展 W316 X D546MM
- 收納 Ø53 X D546MM
- 適用海灣型水槽



ST3013T NT\$ 1050

- 水槽碗盤籃
- DISHES DRAINER
- 304 STAINLESS STEEL
- W510X D188 X H110MM
- 內徑W325 X D175 X H95MM

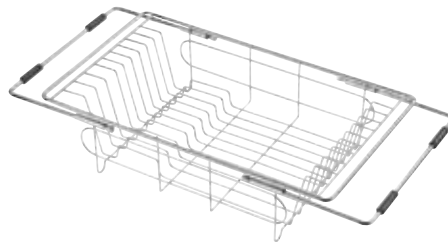

ST3013TL NT\$ 2050

- 可調式水槽碗盤籃
- ADJUSTABLE SINK BASKET
- 304 STAINLESS STEEL
- W430 X D255 X H110MM (全展 545MM)
- 內徑 W325 X D238 X H90MM



ST3013TD NT\$ 2300

(實景詳見下圖)

- 可調式水槽碗盤籃
- 附 3061-30 滴水盤 X1
- ADJUSTABLE SINK BASKET WITH PLATE
- 304 STAINLESS STEEL
- W430 X D255 X H130MM (全展 545MM)
- 內徑 W325 X D238 X H90MM



ST3051 NT\$ 1300

(實景詳見頁 43)

- 馬克杯架
- MUG TREE
- 304 STAINLESS STEEL
- W180 X D180 X H330MM



3010TC NT\$ 1850

- 可調式高腳杯架 桌上型
- ADJUSTABLE HANGING GLASS STAND
- 304 STAINLESS STEEL & 青銅材質
- W320 X D285 X H205MM(全展 355MM)
- 高腳杯入口徑 120MM

NEW



ST3003-07 NT\$ 1100

- 餐具桶
- 隔板可拆洗
- CUTLERY HOLDER
- 304 STAINLESS STEEL
- W121 X D75 X H110MM

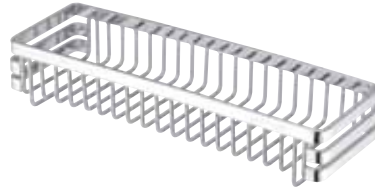

ST3003-02 NT\$ 1000

- 平放筷架
- CUTLERY HOLDER
- 304 STAINLESS STEEL
- W265 X D62 X H49MM



ST3003TS NT\$ 850
(實景詳見頁 40)

- 餐具桶
- CUTLERY HOLDER
- 304 STAINLESS STEEL
- W82 X D100 X H120MM



ST3003T NT\$ 1400

(實景詳見頁 43)

- 餐具桶 - 長方型
- CUTLERY HOLDER
- 304 STAINLESS STEEL
- W178 X D103 X H151MM



ST3003TL NT\$ 1500

- 餐具桶 - 長方型
- 附滴水盤
- CUTLERY HOLDER
- 304 STAINLESS STEEL
- W212 X D107 X H152MM



ST3003-01 NT\$ 1500

- 餐具桶
- CUTLERY HOLDER
- 304 STAINLESS STEEL
- W195 X D81 X H118MM



ST3003TT NT\$ 1700

- 餐具桶 - 長方型 掛式
- CUTLERY HOLDER
- 304 STAINLESS STEEL
- W178 X D126 X H290MM



ST3003TF NT\$ 1800

- 餐具桶 - 長方型 掛式
- 附滴水盤
- CUTLERY HOLDER
- 304 STAINLESS STEEL
- W212 X D132 X H290MM



ST3003 NT\$ 900

- 餐具桶 掛、放兩用
- CUTLERY HOLDER
- 304 STAINLESS STEEL
- W116 X D116 X H275MM



ST3016ST NT\$ 1450

- 杯子架 六個入
- 附 3061-25 滴水盤 X1
- CUP STAND
- 304 STAINLESS STEEL
- W265 X D165 X H230MM



ST3016LT NT\$ 1700

(實景詳見上圖)

- 杯子架 八個入
- 附 3061-25L 滴水盤 X1
- CUP STAND L
- 304 STAINLESS STEEL
- W305 X D165 X H235MM



ST3016 NT\$ 950

- 杯子架 六個入
- 附 3061-25 滴水盤 X1
- CUP STAND
- 304 STAINLESS STEEL
- W245 X D160 X H215MM



ST3016L NT\$ 1050

- 杯子架 八個入
- 附 3061-25L 滴水盤 X1
- CUP STAND L
- 304 STAINLESS STEEL
- W300 X D165 X H225MM



ST3053 NT\$ 1700

(實景詳見左圖)

- 蛋糕架
- 不附盤子
- 盤子尺寸建議：Ø175~230MM
- CAKE HOLDER
- 304 STAINLESS STEEL
- W240 X D125 X H378MM

NEW



ST3018LT NT\$ 1550

- 咖啡杯架 六個入
- 附 3061-25L 滴水盤 X1
- COFFEE CUP STAND
- 304 STAINLESS STEEL
- W310 X D170 X H237MM



ST3005-01 NT\$ 450

- 湯勺架
- 附 3061-10 滴水盤 X1
- SPOON HOLDER
- 304 STAINLESS STEEL
- Ø 120 X H48MM



ST3005 NT\$ 600

- (實景詳見頁 32)
- 餐具架 桌上型
 - 附 3061-10 滴水盤 X1
 - SPOON HOLDER
 - 304 STAINLESS STEEL
 - W110 X D116 X H270MM



ST3203F NT\$ 1300

- 海綿置物架 - 掛式
- 附 3061-20 滴水盤 X1
- SPONGE HOLDER W/PATE
- 304 STAINLESS STEEL
- W225 X D172 X H285MM

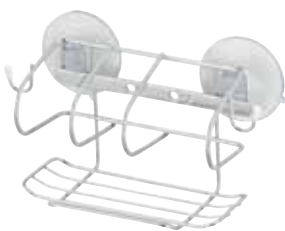

ST3201 NT\$ 400

- 海綿架(附吸盤、螺絲)
- SPONGE HOLDER
- 304 STAINLESS STEEL
- W155 X D73 X H87MM



ST3202 NT\$ 800

- (實景詳見 44 下圖)
- 海綿瓶罐籃(附吸盤 螺絲)
 - SPONGE AND BOTTLE HOLDER
 - 304 STAINLESS STEEL
 - W180 X D130 X H100MM



ST3203D NT\$ 950

- 海綿置物架
- 附 3061-20 滴水盤 X1
- 附滴水盤 吸盤 螺絲
- SPONGE HOLDER W/PLATE
- 304 STAINLESS STEEL
- W225 X D125 X H85MM



ST3202Z NT\$ 950

- 海綿瓶罐籃
- 附 2800C 固定掛架
- 304 STAINLESS STEEL
- W180 X D130 X H100MM



ST3203Z NT\$ 1100

- 海綿置物架
- 附 2800C 固定掛架
- 304 STAINLESS STEEL
- W225 X D125 X H85MM



2800C 不鏽鋼色 NT\$ 150

- 固定掛架(不鏽鋼色
ST3201~ST3203D專用)
- HOLDER (USED BY
ST3201~ST3203D)
- BRASS 青銅材質



3200P NT\$ 10/一個

- 吸盤
- 適用 ST3201、ST3202、
ST3203D





ST3010SC NT\$ 600

- W327 X D150 X H40MM

ST3010LC NT\$ 650

- W387 X D150 X H40MM

- 高腳杯架
- 入口徑 120MM
- GOBLET RACK
- 304 STAINLESS STEEL



ST3010SC-2 NT\$ 1100

- W327 X D285 X H40MM

ST3010LC-2 NT\$ 1250

- W387 X D285 X H40MM

- 雙排高腳杯架
- 入口徑 120MM
- GOBLET RACK DOUBLE
- 304 STAINLESS STEEL



ST3012SC NT\$ 750

- 吊杯架 (小)
- HANGING CUP RACK S
- 304 STAINLESS STEEL
- W300 X D86 X H50MM



ST3012LC NT\$ 850

- 吊杯架 (大)
- HANGING CUP RACK L
- 304 STAINLESS STEEL
- W360 X D86 X H50MM



1001L 乳白色 NT\$ 140

- 雙隔調味盒
- SEASONING CASE
- ABS塑膠
- W90 X D150 X H115MM



1001S 乳白色 NT\$ 120

- 單隔調味盒
- SEASONING CASE
- ABS塑膠
- W70 X D150 X H115MM



3061-20 NT\$ 85

- W203 X D140MM

3061-25 NT\$ 130

- W256 X D155MM

3061-25L NT\$ 150

- W300 X D155MM

3061-30 NT\$ 170

- W300 X D215MM

3061-50 NT\$ 350

- W475 X D240MM

- 滴水盤
- MELAMINE DISH
- 美耐皿

3061-10 NT\$ 55

- 圓滴水盤
- SMALL ROUND PLATE
- 美耐皿
- φ 110MM





NEW

V1030L NT\$ 5600

- 電子感應自動環保桶 - 橫向
- 430 不鏽鋼桶身 不鏽鋼色
- 附分隔式 可分類內桶
- 橫向向上
- 容量：30L (13+17L)
- W416 X D288 X H458MM
- 附 1 號電池 X 2



V1016L NT\$ 3200

- 電子感應自動環保桶 - 方型
- ABS 白色
- AUTO SENSITIVE DUSTBIN
- 方型上掀
- 容量：16L
- W240 X D241 X H383MM
- 附 3 號電池 X 2



V1012LG NT\$ 3500

(實景詳見頁 46)

- 電子感應自動環保桶 - 橫向
- 430 不鏽鋼烤漆桶身 黑色
- AUTO SENSITIVE DUSTBIN
- 橫向上掀
- 容量：12L
- W261 X D198 X H355MM
- 附 3 號電池 X 2



V1012LF NT\$ 3500

- 電子感應自動環保桶 - 橫向
- 430 不鏽鋼桶身 不鏽鋼色
- AUTO SENSITIVE DUSTBIN
- 橫向上掀
- 容量：12L
- W261 X D198 X H355MM
- 附 3 號電池 X 2



V1008LA NT\$ 2400

- 電子感應自動環保桶 - 半圓
- ABS 白色
- AUTO SENSITIVE DUSTBIN
- 半圓上掀
- 容量：8L
- W244 X D191 X H280MM
- 附 3 號電池 X 2



V1012LH NT\$ 3500

- 電子腳觸自動環保桶 - 半圓
- 430 不鏽鋼桶身
- AUTO SENSITIVE DUSTBIN
- 半圓上掀
- 容量：12L
- W264 X D237 X H370MM
- 附 3 號電池 X 2



NEW

V1007LG NT\$ 2700

- 電子感應自動環保桶 - 直向
- 430 不鏽鋼桶身 黑色
- AUTO SENSITIVE DUSTBIN
- 縱向上掀
- 容量：7L
- W150 X D230 X H283MM
- 附 3 號電池 X 2



NEW

V1007LF NT\$ 2700

- 電子感應自動環保桶 - 直向
- 430 不鏽鋼桶身 不鏽鋼色
- AUTO SENSITIVE DUSTBIN
- 縱向上掀
- 容量：7L
- W150 X D230 X H283MM
- 附 3 號電池 X 2



SA-15CT51 NT\$ 2600

- 縱向長方形垃圾桶
- 430 不鏽鋼桶身 (厚度 0.4MM)
- 緩降腳踏式
- DUSTBIN
- 容量：15L
- W230 X D405 X H445MM
- 塑膠內桶
W200 X D295 X H340MM



SA-12CH66 NT\$ 2400

- 四方形垃圾桶
- 430 不鏽鋼桶身 (厚度 0.4MM)
- 緩降腳踏式
- DUSTBIN
- 容量 12L
- W252 X D320 X H450MM
- 塑膠內桶
- W240 X D235 X H350MM



NEW

SA005L-05 NT\$ 1400

- 5L 直向垃圾桶 - 黑色
- 冷軋鋼板 (厚度 0.3MM)
- 緩降腳踏式
- DUSTBIN
- 容量：5L
- W140 X D280 X H290MM
- 塑膠內桶：材質 PP
- W135 X D225 X H240MM



NEW

SA012L-02 NT\$ 2300

- 12L 橫向垃圾桶 - 不鏽鋼色
- 410 不鏽鋼桶身 (厚度 0.3MM)
- 緩降腳踏式
- DUSTBIN
- 容量：12L
- W285 X D245 X H383MM
- 塑膠內桶：材質 PP
- W280 X D183 X H350MM



NEW

SA005L-06 NT\$ 1400

- 5L 橫向垃圾桶 - 不鏽鋼色
- 410 不鏽鋼桶身 (厚度 0.3MM)
- 緩降腳踏式
- DUSTBIN
- 容量：5L
- W215 X D185 X H300MM
- 塑膠內桶：材質 PP
- W208 X D140 X H250MM



清潔方式：

請使用清水或中性清潔劑與乾布搭配擦拭表面，接著再使用柔軟乾布輕擦並待其自然乾燥，勿用鋼刷刷洗。

注意事項：

- 請使用中性清潔劑與乾布搭配擦拭表面
- 勿接近高溫 and 火源
- 勿擠壓或碰撞重摔，以免商品變形
- 避免潮濕



關於歐瓦

AWA歐瓦廚衛精品水龍頭，以「創造智慧而精工」為品牌信仰，產品堅守設計、兼顧對人和環境的尊重、可回收再利用的材質與經久實用的品質，過去已多年成功營銷歐美市場。

歐瓦創辦人駱奎思 (Christian Laudet) 擁有長時間的水龍頭生產經驗，他個人曾分別於2010與2011年獲得德國紅點設計獎 (Red Dot Award)，不僅於此，駱奎思更在成立歐瓦之後，再度獲得2013、2015紅點設計獎的肯定。與彰化鹿港水龍頭生產基地互動將近30年至今，積累豐富的台灣經驗。駱奎思觀察台灣民眾逐年地擴展設計接受度，決定帶領團隊於2015年正式在台灣啟動。結合省水節能的環保需求、視覺加上手感的震撼設計，企圖將歐洲追求迷人生活的精神引入台灣廚衛空間。

「現代法式設計，台灣製造」——是歐瓦行腳台灣的核心，由法國設計師領軍多元文化的團隊，熱愛台灣、熱愛設計，堅信優雅、智慧、實用的產品可以在台灣令國際信賴的生產技術中實現，並以技術、設計、價格競爭力三面向的謹慎考量，制定台灣市場策略。



環保設計：

- **環保省水起泡頭**

歐瓦使用德國高級紐珀(Neoperl)起泡頭濾網，讓水流混合空氣，水流綿密不外濺。產生極佳的觸感，省水40%。

- **輕鬆清洗起泡頭—出水口的起泡頭容易拆除清洗**

自來水經自來水廠、水管、水塔等管道進入家中的水龍頭，會夾雜細沙及小石頭阻塞在出水的濾網。歐瓦的起泡器僅使用銅板或一字起旋轉的方式即可打開清洗。(一般傳統須使用鉗子等工具才可以打開清洗)

- **可回收銅鑄造**

全銅製造，響應環保，可回收再利用。



輕鬆清洗起泡頭



可回收銅鑄造





FLEAKER 檯面無鉛伸縮龍頭

EA-211-GB 黑色烤漆 X 玫瑰金 NT\$ 17200

EA-211-N 絲光鍍銀 NT\$ 16600

- 省水起泡頭濾網
- 高品質下抽拉伸縮軟管握把
- 握把經隔熱處理避免燙傷

EA-211-01

NT\$ 3200

- 雙重噴頭花灑握把

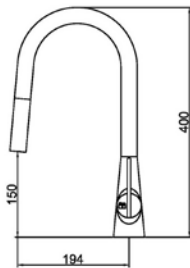

SHERLOCK 花灑 檯面無鉛伸縮龍頭

EA-072-N 絲光鍍銀 NT\$ 16500

- 省水起泡頭濾網
- 雙重噴頭花灑功能

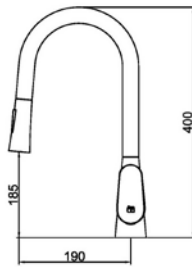

OPHIR 花灑 檯面無鉛伸縮龍頭

EA-353-B 黑色烤漆 NT\$ 16800

- 省水起泡頭濾網
- 雙重噴頭花灑功能

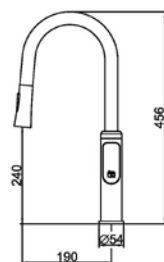

NEW

JUN 檯面無鉛龍頭

EA-193-GB 黑色烤漆 x 玫瑰金 NT\$ 17900

- 省水起泡頭濾網
- 輕鬆清洗起泡頭濾網
- 高品質軟管握把
- 握把經隔熱處理避免燙傷
- 可活動及收納式軟管

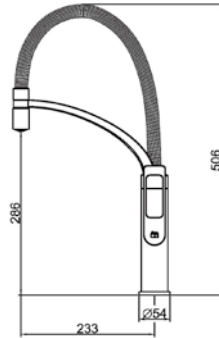

JUN 檯面無鉛龍頭

EA-314-GB 黑色烤漆 x 玫瑰金 NT\$ 17500

- 省水起泡頭濾網
- 輕鬆清洗起泡頭濾網
- 高品質軟管握把
- 握把經隔熱處理避免燙傷
- 可活動及收納式軟管

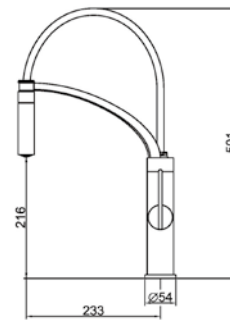

JUN 檯面無鉛龍頭

EA-168-N 絲光鍍鎳 NT\$ 16500

(實景詳見頁 49)

- 省水起泡頭濾網
- 輕鬆清洗起泡頭濾網
- 高品質軟管握把
- 握把經隔熱處理避免燙傷
- 可活動及收納式軟管

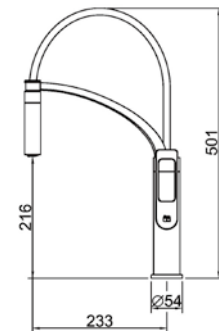

JUN 檯面無鉛龍頭

EA-168-GC 香檳金 x 鍍鉻 NT\$ 16500

EA-168-BC 藍色 x 鍍鉻 NT\$ 16500

EA-168-RC 紅色 x 鍍鉻 NT\$ 16500

- 省水起泡頭濾網
- 輕鬆清洗起泡頭濾網
- 高品質軟管握把
- 握把經隔熱處理避免燙傷
- 可活動及收納式軟管

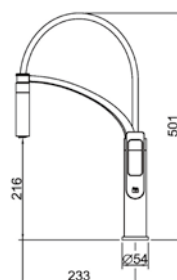

ROBIN 三用檯面龍頭

EA-333-GB 黑色 x 玫瑰金

NT\$ 19800

(實景詳見下圖)

- 三用檯面龍頭
- 輕鬆清洗起泡頭濾網
- 分流設計
- 高品質軟管握把
- 握把經隔熱處理避免燙傷
- 可活動及收納式軟管

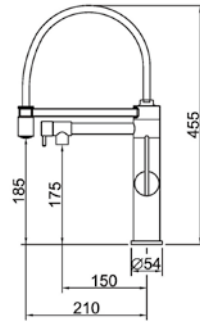

ROBIN 三用檯面龍頭

EA-333-GC 香檳金 x 鍍鉻

NT\$ 19800

EA-333-BC 藍色 x 鍍鉻

NT\$ 19800

EA-333-RC 紅色 x 鍍鉻

NT\$ 19800

- 三用檯面龍頭
- 輕鬆清洗起泡頭濾網
- 分流設計
- 高品質軟管握把
- 握把經隔熱處理避免燙傷
- 可活動及收納式軟管

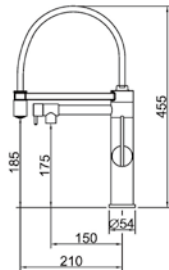



ROBIN 檯面無鉛龍頭

EA-194-N 絲光鍍銀

NT\$ 14700

- 省水起泡頭濾網
- 輕鬆清洗起泡頭濾網
- 高品質軟管握把
- 握把經隔熱處理避免燙傷
- 可活動及收納式軟管

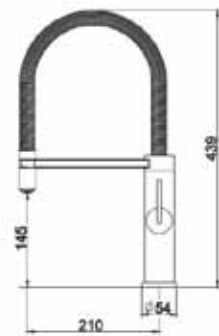

HANDY 檯面無鉛龍頭

EA-022-GB 黑色 X 玫瑰金

NT\$ 9200

- 省水起泡頭濾網
- 輕鬆清洗起泡頭濾網
- 可旋轉 U 型噴嘴

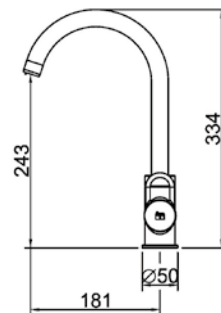

SHERLOCK 檯面無鉛龍頭

EA-071-GB 黑色 X 玫瑰金

NT\$ 17000

(實景詳見上圖)

- 省水起泡頭濾網
- 輕鬆清洗起泡頭濾網

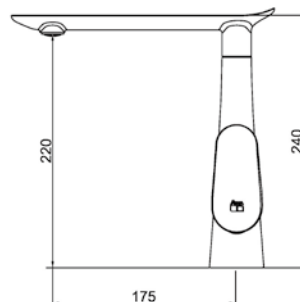

NEW

ANGO 檯面無鉛龍頭

EA-161-C 鍍鉻	NT\$ 13800
EA-161-N 絲光鍍鉻	NT\$ 15500
EA-161-GB 黑色 X 玫瑰金	NT\$ 15500

- 省水起泡頭濾網
- 輕鬆清洗起泡頭濾網

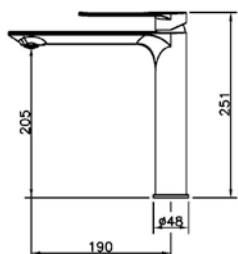

黑色 X 玫瑰金

鍍鉻

絲光鍍鉻

OPHIR 檯面無鉛龍頭

EA-135-C 鍍鉻	NT\$ 13800
EA-135-N 絲光鍍鉻	NT\$ 15500
EA-135-GB 黑色 X 玫瑰金	NT\$ 15500

- 省水起泡頭濾網
- 輕鬆清洗起泡頭濾網
- 旋轉管身



黑色 X 玫瑰金

鍍鉻

絲光鍍鉻

NEW

SYDENY 檯面無鉛龍頭

EA-105-C 鍍鉻	NT\$ 13800
EA-105-N 絲光鍍鉻	NT\$ 15500
EA-105-GB 黑色 X 玫瑰金	NT\$ 15500

- 省水起泡頭濾網
- 輕鬆清洗起泡頭濾網
- 旋轉管身
- 適合小型廚房
- 德國紅點設計大獎

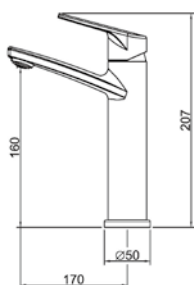

黑色 X 玫瑰金

鍍鉻

絲光鍍鉻

NEW





Declaration of brass composition
relative to Lead Free

Awa Faucet Ltd products are made of
“Lead Free” (<0.25% of Pb) compliant materials
when in contact with water based on CNS 8088

歐瓦所製造的無鉛龍頭符合水龍頭國家標準CNS8088，其原料鉛含量低於0.25%。



— 歐瓦龍頭採用以下高級配件 —

無鉛三角凡爾



銅製P管



銅製落水頭





OPHIR 浴室無鉛感應式龍頭

EA-325-C 絲光鍍銀

NT\$ 15700

- 非接觸式，紅外線 IR 感應出水
- 更易省水，用水完畢即自動關水
- 省水起泡頭濾網
- 輕鬆清洗起泡頭濾網
- 單冷水（不可調節水溫）
- 附電池（CR123A 2 顆）

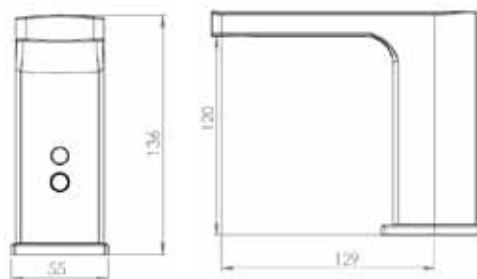

NEW

COR IR 浴室無鉛感應式龍頭

EA-327-B 黑色烤漆 X 白色

NT\$ 16500

（實景詳見上圖）

- 材質可麗耐 (Corian®): 易清潔，耐髒污。
- 非接觸式，紅外線 IR 感應出水
- 更易省水，用水完畢即自動關水
- 省水起泡頭濾網
- 輕鬆清洗起泡頭濾網
- 單冷水（不可調節水溫）
- 附電池（CR123A 2 顆）

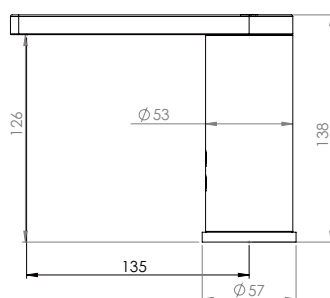

NEW

COR 浴室無鉛龍頭

EA-225-N 絲光鍍銀 NT\$ 15800

EA-227-N 增高 - 絲光鍍銀 NT\$ 17400

- 材質可麗耐 (Corian®) :
易清潔，較不易卡髒污
- 普通高度 / 增高 二種樣式

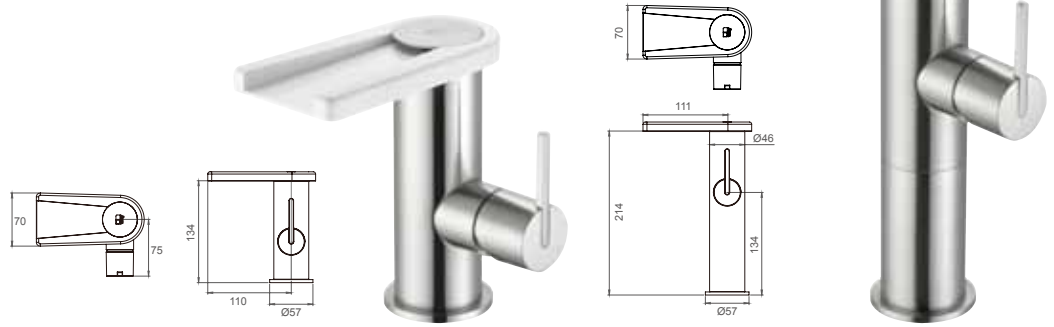

INKY 浴室無鉛龍頭

EA-002-B 黑色烤漆 NT\$ 14700

EA-002-C 鍍鉻 NT\$ 13900

EA-099-C 增高-鍍鉻 NT\$ 14700

- 彷彿從竹子中流出水來
- ECO 節能手把
- 普通高度 / 增高 二種樣式

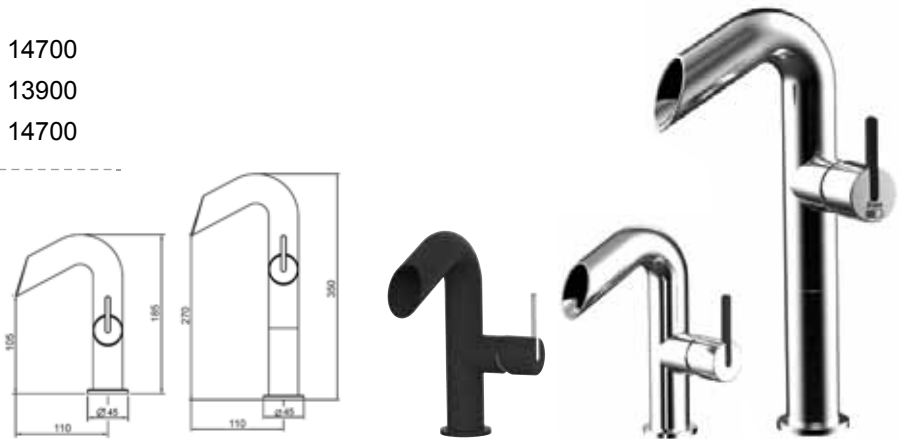

ZENAWA 浴室無鉛龍頭

EA-025-N 鍍銀 NT\$ 14700

- 彷彿從竹子中流出水來

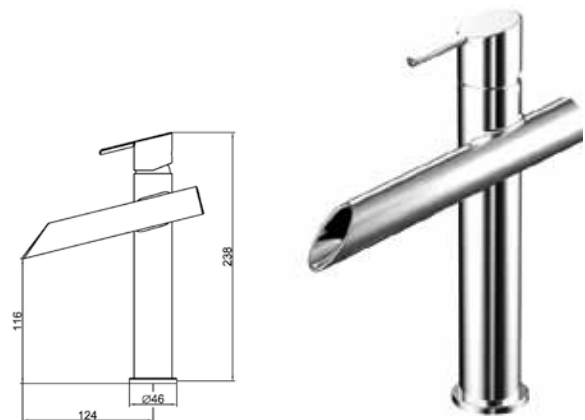

JUN 浴室無鉛龍頭

EA-340-GC 香檳金 X 鍍鉻 NT\$ 12000

EA-340-BC 藍色 X 鍍鉻 NT\$ 12000

EA-340-RC 紅色 X 鍍鉻 NT\$ 12000

- 省水起泡頭濾網
- 輕鬆清洗起泡頭濾網
- 高品質軟管握把
- 握把經隔熱處理避免燙傷
- 可活動及收納式軟管



NEW

ANGO 沐浴龍頭

EA-320-C 鍍鉻

NT\$ 15200

EA-320-N 絲光鍍鉻

NT\$ 17500

NEW

- 省水起泡頭濾網
- 輕鬆清洗起泡頭
- 一手輕鬆調控
- 特殊閥心，輕鬆調溫
- 把手往上撥，上方蓮蓬頭出水
把手往下撥，下方出水口出水
- 附 ABS 蓮蓬頭
- 附 ABS 固定座
- 附 304 不鏽鋼 150CM 軟管
- 附高級止水彎頭

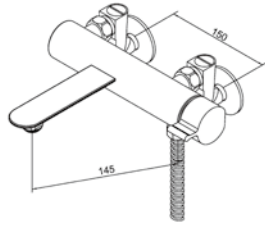

鍍鉻



絲光鍍鉻

SYDNEY 沐浴龍頭

EA-318-C 鍍鉻

NT\$ 15200

EA-318-N 絲光鍍鉻

NT\$ 17500

NEW

- 省水起泡頭濾網
- 輕鬆清洗起泡頭
- 一手輕鬆調控
- 特殊閥心，輕鬆調溫
- 把手往上撥，上方蓮蓬頭出水
把手往下撥，下方出水口出水
- 附 ABS 蓮蓬頭
- 附 ABS 固定座
- 附 304 不鏽鋼 150CM 軟管
- 附高級止水彎頭

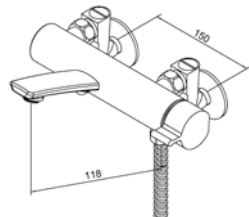

鍍鉻



絲光鍍鉻

OPHIR 沐浴龍頭

EA-321-C 鍍鉻

NT\$ 15200

EA-321-N 絲光鍍鉻

NT\$ 17500

NEW

- 省水起泡頭濾網
- 輕鬆清洗起泡頭
- 一手輕鬆調控
- 特殊閥心，輕鬆調溫
- 把手往上撥，上方蓮蓬頭出水
把手往下撥，下方出水口出水
- 附 ABS 蓮蓬頭
- 附 ABS 固定座
- 附 304 不鏽鋼 150CM 軟管
- 附高級止水彎頭

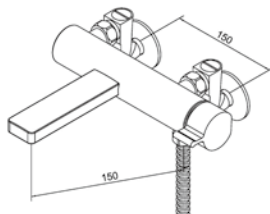

鍍鉻



絲光鍍鉻

NEW

ANGO 浴室無鉛龍頭

- EA-160-C** 鍍鉻 NT\$ 12300
- EA-160-N** 絲光鍍鉻 NT\$ 13300
- EA-160-GB** 黑色 X 玫瑰金 NT\$ 13300

- 省水起泡頭濾網
- 輕鬆清洗起泡頭濾網

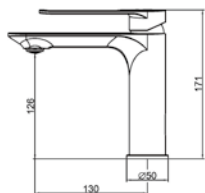

黑色 X 玫瑰金

鍍鉻

絲光鍍鉻

SYDNEY 浴室無鉛龍頭

- EA-073-C** 鍍鉻 NT\$ 12300
- EA-073-N** 絲光鍍鉻 NT\$ 13300
- EA-073-GB** 黑色 X 玫瑰金 NT\$ 13300

- 省水起泡頭濾網
- 輕鬆清洗起泡頭濾網
- 德國紅點設計大獎

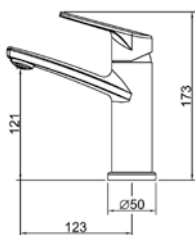

黑色 X 玫瑰金

鍍鉻

絲光鍍鉻

NEW

HUBLO 浴室無鉛龍頭

- EA-164-C** 鍍鉻 NT\$ 12300
- EA-164-N** 絲光鍍鉻 NT\$ 13300
- EA-164-GB** 黑色 X 玫瑰金 NT\$ 13300

- 省水起泡頭濾網
- 輕鬆清洗起泡頭濾網

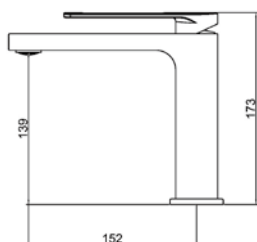

黑色 X 玫瑰金

鍍鉻

絲光鍍鉻

NEW



ED-KS4020

NT\$ 10900

- 304 不鏽鋼無鉛龍頭
- 流線型伸縮花灑檯面龍頭
- 附 304 不鏽鋼加長型三角凡而
- 日本陶瓷閥芯

NEW



ED-KS4021

NT\$ 13500

- 304 不鏽鋼無鉛龍頭
- 暮灰色
- 流線型伸縮花灑檯面龍頭
- 附 304 不鏽鋼加長型三角凡而
- 日本陶瓷芯

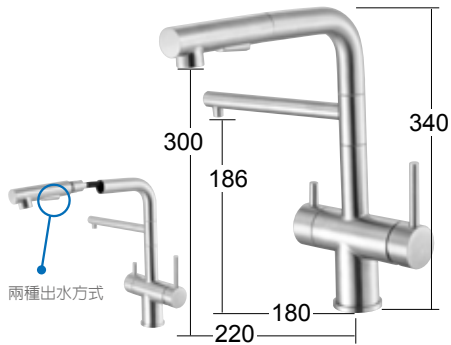

ED-KS4022LT

NT\$ 16600

- 304 不鏽鋼無鉛龍頭
- 三用伸縮花灑檯面龍頭
- 附 304 不鏽鋼加長型三角凡而
- 日本陶瓷閥芯

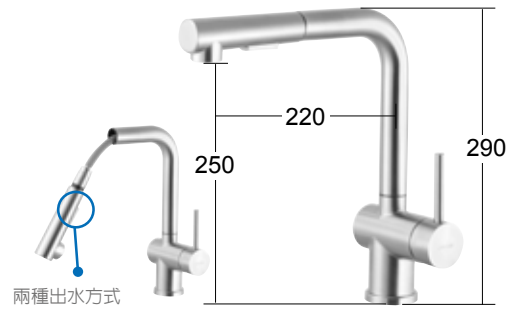

ED-KS83508

NT\$ 9900

- 304 不鏽鋼無鉛龍頭
- 伸縮花灑檯面龍頭
- 附 304 不鏽鋼加長型三角凡而



ED-KS83501

NT\$ 5300

- 304 不鏽鋼無鉛龍頭
- 檯面龍頭
- 附 304 不鏽鋼加長型三角凡而

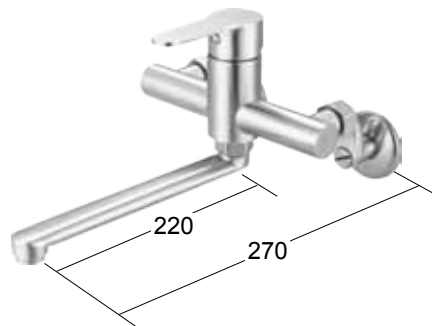

ED-KS83506

NT\$ 6400

- 304 不鏽鋼無鉛龍頭
- 壁式龍頭
- 附 304 不鏽鋼止水彎頭



ED-KS83507

NT\$ 5600

- 304 不鏽鋼無鉛龍頭
- 檯面龍頭
- 附 304 不鏽鋼加長型三角凡而



ED-KA4905-B NT\$ 16300

- PVD 花灑檯面龍頭
- 黑色 + 玫瑰金
- 附 304 不鏽鋼加長型三角凡而
- 日本陶瓷閥芯



ED-KA4308-B NT\$ 14300

- PVD 伸縮花灑檯面龍頭
- 黑色 + 玫瑰金
- 附 304 不鏽鋼加長型三角凡而
- 日本陶瓷閥芯



ED-KA4903-B NT\$ 12200

- PVD 花灑檯面龍頭
- 黑色 + 玫瑰金
- 附 304 不鏽鋼加長型三角凡而
- 日本陶瓷閥芯



ED-K11618-07BK NT\$ 7600

- 檯面龍頭 黑色
- 附銅製加長型三角凡而

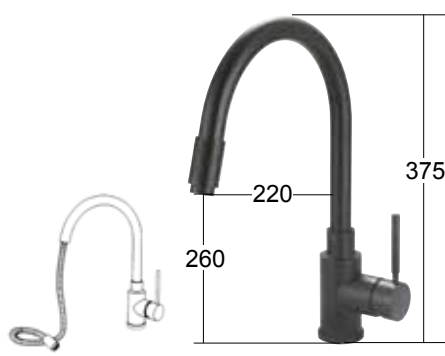

ED-K11311BK NT\$ 9900

- 伸縮檯面龍頭 黑色
- 附銅製加長型三角凡而



ED-K11311 NT\$ 7400

- 伸縮檯面龍頭
- 附銅製加長型三角凡而

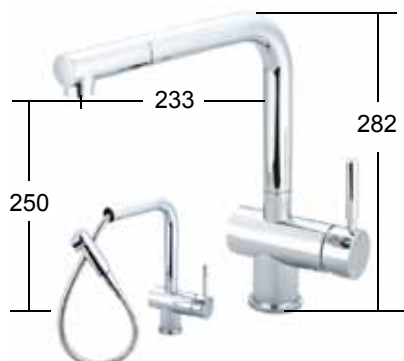

ED-11321 NT\$ 8400

- 伸縮檯面龍頭
- 附銅製加長型三角凡而



ED-10368 NT\$ 5400

- 檯面龍頭
- 附銅製加長型三角凡而



ED-FS20171 NT\$ 7500

- 304 不鏽鋼無鉛龍頭
- 臉盆龍頭
- 附 304 不鏽鋼加長型三角凡而
- 附銅製按壓式落水頭
- 附銅製 P 管
- 日本陶瓷閥芯

NEW



ED-HS4016 NT\$ 15000

- 304 不鏽鋼無鉛龍頭
- 沐浴龍頭組
- 附 304 不鏽鋼蓮蓬頭
- 附 304 不鏽鋼 150CM 軟管
- 附 304 大流量止水彎頭
- 日本陶瓷閥芯

產品特色

- 水龍頭出水管向左撥，上方蓮蓬頭出水，不佔淋浴空間。
- 出水口置於中間，下方出水管出水。



ED-HS4018-01 NT\$ 12200

- 304 不鏽鋼無鉛龍頭
- 沐浴龍頭組
- 附 304 不鏽鋼蓮蓬頭
- 附 304 不鏽鋼固定座
- 附 304 不鏽鋼 150CM 軟管
- 附 304 大流量止水彎頭
- 日本陶瓷閥芯



ED-FS20173A NT\$ 7500

- 304 不鏽鋼無鉛龍頭
- 臉盆龍頭
- 附 304 不鏽鋼加長型三角凡而
- 附銅製按壓式落水頭
- 附銅製 P 管
- 日本陶瓷閥芯



D-HS4017A-01 NT\$ 13800

- 304 不鏽鋼無鉛龍頭
- 沐浴龍頭組
- 304 不鏽鋼蓮蓬頭
- 附 304 不鏽鋼固定座
- 附 304 不鏽鋼 150CM 軟管
- 附 304 大流量止水彎頭
- 日本陶瓷閥芯



ED-FS18766 NT\$ 8600

- 304 不鏽鋼無鉛龍頭
- 臉盆龍頭
- 附 304 不鏽鋼蓮蓬頭
- 附 304 不鏽鋼固定座
- 附 304 不鏽鋼 150CM 軟管
- 附 304 不鏽鋼三角凡而
- 附銅製按壓式落水頭
- 附銅製 P 管

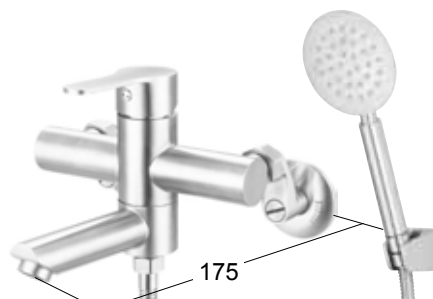

ED-HS28765 NT\$ 7300

- 304 不鏽鋼無鉛龍頭
- 沐浴龍頭組
- 附 304 不鏽鋼蓮蓬頭
- 附 304 不鏽鋼固定座
- 附 304 不鏽鋼 150CM 軟管
- 附 304 不鏽鋼止水彎頭

產品特色

- 水龍頭出水管向左撥，上方蓮蓬頭出水，不佔淋浴空間。
- 出水管置於中間，下方出水管出水。



ED-FS18761 NT\$ 6800

- 304 不鏽鋼無鉛龍頭
- 臉盆龍頭
- 附 304 不鏽鋼三角凡而
- 附銅製按壓式落水頭
- 附銅製 P 管



ED-FS18763 NT\$ 6200

- 304 不鏽鋼無鉛龍頭
- 臉盆龍頭
- 附 304 不鏽鋼三角凡而
- 附銅製按壓式落水頭
- 附銅製 P 管

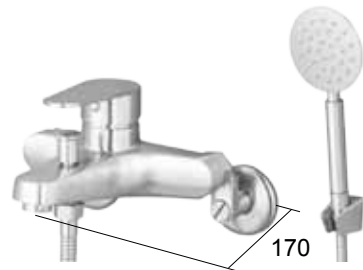

ED-HS28761 NT\$ 8400

- 304 不鏽鋼無鉛龍頭
- 沐浴龍頭組
- 附 304 不鏽鋼蓮蓬頭
- 附 304 不鏽鋼固定座
- 附 304 不鏽鋼 150CM 軟管
- 附 304 不鏽鋼止水彎頭

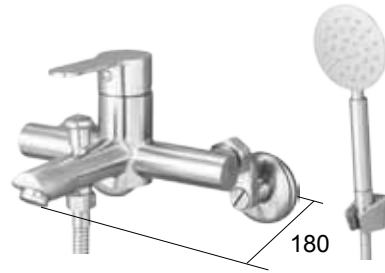

ED-HS28763 NT\$ 7300

- 304 不鏽鋼無鉛龍頭
- 沐浴龍頭組
- 附 304 不鏽鋼蓮蓬頭
- 附 304 不鏽鋼固定座
- 附 304 不鏽鋼 150CM 軟管
- 附 304 不鏽鋼止水彎頭



ED-VS8655 NT\$ 2900

- 304 不鏽鋼
- 沖洗器
- 附 304 不鏽鋼固定座
- 附 304 不鏽鋼 150CM 軟管
- 附 304 不鏽鋼控制閥進水三通



ED-VS8655A NT\$ 2600

- 304 不鏽鋼
- 沖洗器
- 附 304 不鏽鋼固定座
- 附 304 不鏽鋼 150CM 軟管
- 附 304 不鏽鋼三角凡而



ED-VS8651 NT\$ 2200

- 304 不鏽鋼
- 沖洗器
- 附 304 不鏽鋼固定座
- 附 304 不鏽鋼 150CM 軟管
- 附 304 不鏽鋼控制閥進水三通



ED-VS8651A NT\$ 1900

- 304 不鏽鋼
- 沖洗器
- 附 304 不鏽鋼固定座
- 附 304 不鏽鋼 150CM 軟管
- 附 304 不鏽鋼三角凡而



ED-F10753BK NT\$ 9000

(實景詳見頁 27)

- 臉盆龍頭 黑色
- 附銅製三角凡而
- 附銅製按壓式落水頭
- 附銅製 P 管



ED-H20753BK NT\$ 11400

- 沐浴龍頭組 黑色
- 附 ABS 蓮蓬頭
- 附青銅固定座
- 附 150CM 軟管
- 附高級止水彎頭



ED-F10753 NT\$ 6900

- 臉盆龍頭
- 附銅製三角凡而
- 附銅製按壓式落水頭
- 附銅製 P 管

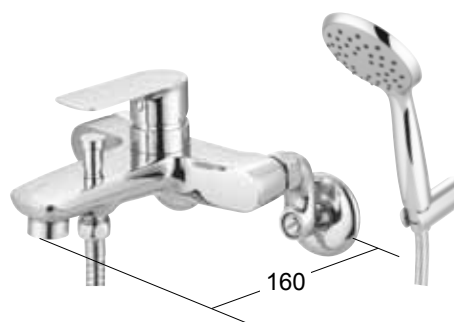

ED-H20753A NT\$ 8250

- 沐浴龍頭組
- 附 ABS 蓮蓬頭
- 附青銅固定座
- 附 304 不鏽鋼 150CM 軟管
- 附高級止水彎頭



ED-F11613R NT\$ 5500

- 臉盆龍頭
- 附銅製三角凡而
- 附銅製按壓式落水頭
- 附銅製 P 管

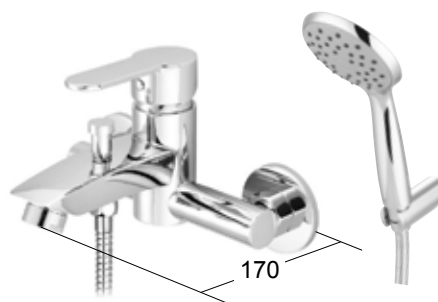

ED-H22613RB NT\$ 7500

- 沐浴龍頭組
- 附 ABS 蓮蓬頭
- 附青銅固定座
- 附 304 不鏽鋼 150CM 軟管
- 附高級止水彎頭



ED-T22462BK
NT\$ 5600

- 滑桿 黑色
- 青銅

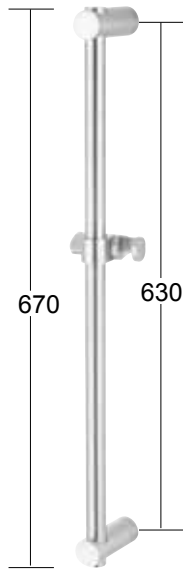

ED-TS01
NT\$ 4200

- 高級活動滑桿
- 304 不鏽鋼

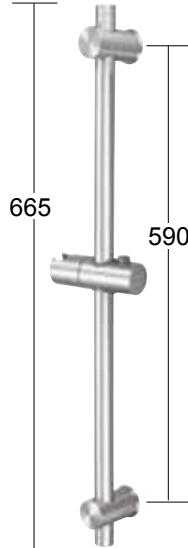

ED-T6507
NT\$ 3500

- 滑桿
- 304 不鏽鋼

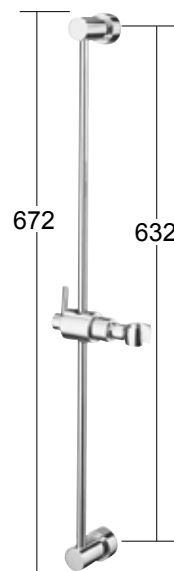

ED-T22462
NT\$ 3950

- 滑桿
- 青銅

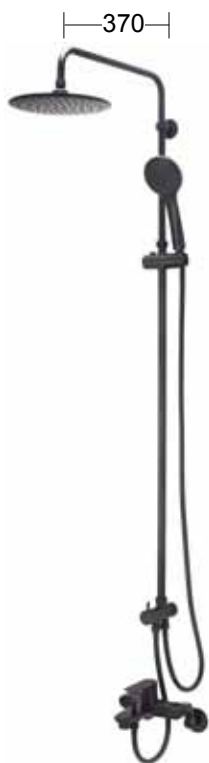

ED-R20753-076BK
NT\$ 21600

- 淋浴柱 黑色
- 直桿高度：115 ~ 143CM
- 附 ABS 蓮蓬頭
- 附 ABS 可調式固定座
- 附 150CM 軟管
- 附高級止水彎頭



ED-RS70016-01
NT\$ 23000

- 304 不鏽鋼無鉛龍頭
- 高級淋浴柱
- 直桿高度：78CM~145CM
- 附 304 不鏽鋼蓮蓬頭
- 附 304 不鏽鋼可調式固定座
- 附 304 不鏽鋼 150CM 軟管
- 附 304 大流量止水彎頭
- 日本陶瓷閥芯



ED-RS28501
NT\$ 16800

- 304 不鏽鋼無鉛龍頭
- 淋浴柱
- 直桿高度：120CM ~ 145CM
- 附 304 不鏽鋼蓮蓬頭
- 附 304 不鏽鋼固定座
- 附 304 不鏽鋼 150CM 軟管
- 附 304 不鏽鋼止水彎頭



ED-R28126-076
NT\$ 17800

- 淋浴柱
- 直桿高度：115CM ~ 143CM
- 附 ABS 蓮蓬頭
- 附 ABS 可調式固定座
- 附 304 不鏽鋼 150CM 軟管
- 附高級止水彎頭



DD9487

NT\$ 26500

- 手工小 R 角方槽
- 髮絲紋
- STAINLESS SINK
- 人造石下嵌、天然石 / 美耐板上裝、不鏽鋼檯面平接

材 質	304 STAINLESS STEEL
外 徑	OUTSIDE DIA. 870X460X220MM
內 徑	INSIDE DIA. 830X420X220MM
厚 度	THICKNESS 1.1MM
適用桶身	90CM 以上
底部貼防潮消音墊、無溢水孔 ST 後置型大提籠、ST 半邊籃、ST 瀝水盆	



DD9477

NT\$ 22300

- 手工小 R 角方槽
- 髮絲紋
- STAINLES SINK
- 人造石下嵌、天然石 / 美耐板上裝、不鏽鋼檯面平接

材 質	304 STAINLESS STEEL
外 徑	OUTSIDE DIA. 770X460X220MM
內 徑	INSIDE DIA. 730X420X220MM
厚 度	THICKNESS 1.1MM
適用桶身	80CM 以上
底部貼防潮消音墊、無溢水孔 ST 後置型大提籠、ST 瀝水盆	



DD9467

NT\$ 19800

- 手工小 R 角方槽
- 髮絲紋
- STAINLESS SINK
- 人造石下嵌、天然石 / 美耐板上裝、不鏽鋼檯面平接

材 質	304 STAINLESS STEEL
外 徑	OUTSIDE DIA. 670X460X220MM
內 徑	INSIDE DIA. 630X420X220MM
厚 度	THICKNESS 1.1MM
適用桶身	70CM 以上
底部貼防潮消音墊、無溢水孔 ST 後置型大提籠、ST 瀝水盆	



DD9456

NT\$ 17900

- 手工小 R 角方槽
- 髮絲紋
- STAINLESS SINK
- 人造石下嵌、天然石 / 美耐板上裝、不鏽鋼檯面平接

材 質	304 STAINLESS STEEL
外 徑	OUTSIDE DIA. 560X460X220MM
內 徑	INSIDE DIA. 520X420X220MM
厚 度	THICKNESS 1.1MM
適用桶身	60CM 以上
底部貼防潮消音墊、無溢水孔 ST 後置型中提籠、方槽用 ST 半邊籃	



DD0166

NT\$ 21600

- 歐式方形大單槽
- 柔絲面
- STAINLESS SINK
- 人造石下嵌、天然石 / 美耐板上裝、不鏽鋼檯面平接

材 質	304 STAINLESS STEEL
外 徑	OUTSIDE DIA. 800x520x230MM
內 徑	INSIDE DIA. 735x460x225MM
厚 度	THICKNESS 1.0MM
適用桶身	80CM 以上
底部貼防潮消音墊、無溢水孔 ST 後置型大提籠、ST 半邊籃、ST 掛籃	



DD0167

NT\$ 16900

- 歐式全四方單槽
- 柔絲面
- STAINLESS SINK
- 人造石下嵌、天然石 / 美耐板上裝、不鏽鋼檯面平接

材 質	STAINLESS STEEL	SUS 304 柔絲面
外 徑	OUTSIDE DIA.	710X450X225MM
內 徑	INSIDE DIA.	680X420X220MM
厚 度	THICKNESS	1.0MM
適用桶身		75CM 以上
底部貼防潮消音墊、無溢水孔 ST 後置型大提籠、ST 掛籃		



DD9449-01

NT\$ 14900

- 手工小 R 角方槽
- 髮絲紋
- STAINLES SINK
- 人造石下嵌、天然石 / 美耐板上裝、不鏽鋼檯面平接

材 質	STAINLESS STEEL	304 髮絲紋
外 徑	OUTSIDE DIA.	490X460X220MM
內 徑	INSIDE DIA.	450X420X220MM
厚 度	THICKNESS	1.1MM
適用桶身		55CM 以上
ST 後置型中提籠、無溢水孔、底部貼防潮消音墊		



DD9434

NT\$ 12100

- 手工小 R 角方槽
- 髮絲紋
- STAINLES SINK
- 人造石下嵌、天然石 / 美耐板上裝、不鏽鋼檯面平接

材 質	STAINLESS STEEL	304 髮絲紋
外 徑	OUTSIDE DIA.	340X460X220MM
內 徑	INSIDE DIA.	300X420X220MM
厚 度	THICKNESS	1.1MM
適用桶身		40CM 以上
ST 後置型小提籠、無溢水孔、底部貼防潮消音墊		

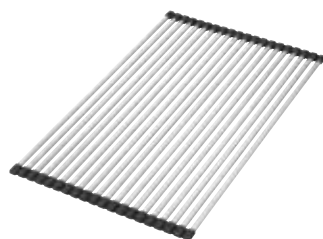

ST3052 NT\$ 3900

(實景詳見左圖)

- 全展 W316 X D506MM
- 收納 Ø53 X D506MM
- 適用四方型水槽



- 滴水捲簾
- ROLLABLE DISHES HOLDER
- 304 STAINLESS STEEL
- 食用級耐熱矽膠
- 20 支 304 不鏽鋼扁條

ST3052L NT\$ 4350

- 全展 W316 X D546MM
- 收納 Ø53 X D546MM
- 適用海灣型水槽



DD0168FN

NT\$ 19500

- 大愛琴海
- 柔絲面
- STAINLESS SINK
- 人造石下嵌、天然石 / 美耐板上裝、不鏽鋼檯面平接

材 質	STAINLESS STEEL	SUS 304 柔絲面
外 徑	OUTSIDE DIA.	820X520X230MM
內 徑	INSIDE DIA.	760X460X215MM
厚 度	THICKNESS	1.0MM
適用桶身	85CM 以上	
底部貼防潮消音墊、無溢水孔		
ST 後置型大提籠、ST 掛籃、ST 半邊籃		



DD0101B

NT\$ 16200

- 愛琴海單槽
- 柔絲面
- STAINLESS SINK
- 人造石下嵌、天然石 / 美耐板上裝、不鏽鋼檯面平接

材 質	STAINLESS STEEL	SUS 304 柔絲面
外 徑	OUTSIDE DIA.	700X510X230MM
內 徑	INSIDE DIA.	650X460X215MM
厚 度	THICKNESS	0.7MM
適用桶身	75CM 以上	
底部貼防潮消音墊、無溢水孔		
ST 後置型大提籠、ST 半邊籃、ST 多功能掛籃		



DD0502

NT\$ 9800

- 大原槽
- 毛絲面
- STAINLESS SINK
- 人造石下嵌、不鏽鋼檯面平接

材 質	304 STAINLESS STEEL	
內 徑	INSIDE DIA.	740X420X200MM
厚 度	THICKNESS	0.7MM
適用桶身	80CM 以上	
底部貼防潮消音墊、有溢水孔		
ST 後置型中提籠		



DD0505

NT\$ 6200

- 大原槽
- 毛絲面
- STAINLESS SINK
- 人造石下嵌、不鏽鋼檯面平接

材 質	304 STAINLESS STEEL	
內 徑	INSIDE DIA.	560X410X200MM
厚 度	THICKNESS	0.6MM
適用桶身	65CM 以上	
底部貼防潮消音墊、有溢水孔		
ST 後置型中提籠		



DD0301-01

NT\$ 6600

- 大橢圓
- 毛絲面
- STAINLESS SINK
- 人造石下嵌、天然石 / 美耐板上裝、不鏽鋼檯面平接

材 質	STAINLESS STEEL	304 毛絲面
外 徑	OUTSIDE DIA.	620X480X205MM
內 徑	INSIDE DIA.	560X410X200MM
厚 度	THICKNESS	0.6MM
適用桶身	65CM 以上	
ST 後置型中提籠、有溢水孔、底部貼防潮消音墊		



DD0006F

NT\$ 7600

- 圓形吧檯槽
- 毛絲面
- ROUND BAR SINK
- 人造石下嵌、天然石 / 美耐板上裝、不鏽鋼檯面平接

材 質	STAINLESS STEEL	304 毛絲面
外 徑	OUTSIDE DIA.	435X435X185MM
內 徑	INSIDE DIA.	380X380X180MM
厚 度	THICKNESS	0.7MM
適用桶身	50CM 以上	
ST 後置型小提籠、無溢水孔、附落水頭		

環保防蟑防臭新型專利 不鏽鋼後置型大提籠

環保防蟑防臭新型專利 不鏽鋼後置型中提籠



◎ 實例圖 適用 18 公分提籠孔



◎ 洗碗機專用接法示意圖



◎ 實例圖 適用 14.5 公分提籠孔

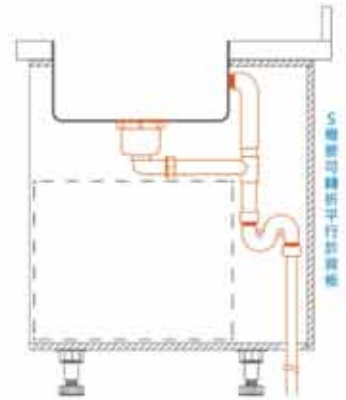

◎ 櫃體安裝示意圖

地排式



地排式



產品特色

後置式設計：

傳統櫥櫃內空間常因排水管置於中間貫穿上下，造成空間難以利用，本公司研發的新型提籠組獨特後置式設計將出口轉向後方，櫥櫃內空間不再因排水管而有所阻礙，無論是搭配櫥下拉籃或是抽屜、隔板都更為方便。

S 彎管防蟑防臭：

下方的 S 彎管設計，利用水將蟑螂及排水管臭味阻絕於外，達到防蟑防臭的效果。

超淺提籠高度：

將水槽下提籠高度由傳統約 30 公分減淺至 15 公分，櫥下空間自由利用。

功能齊全：

沉水彎處預先留有洗碗機排水孔及汙物清潔孔，毋須另行加裝三通配件，櫥下空間更簡潔。



◎ 防蟑防臭示意圖



NEW

ED-VS3007 NT\$ 700

- 蓮蓬頭
- 304 不鏽鋼



ED-VS24089 NT\$ 950

- 蓮蓬頭
- 304 不鏽鋼



ED-VS10S NT\$ 500

- 固定座
- 304 不鏽鋼



ED-V6025CP NT\$ 650

- 蓮蓬頭
- ABS



ED-V24137 NT\$ 550

- 蓮蓬頭
- ABS



ED-V32013 NT\$ 1200

- 三段式蓮蓬頭
- ABS 絲光



ED-VS04055A NT\$ 580

- 加密軟管
- 304 不鏽鋼
- 150CM



ED-V04055BK NT\$ 850

- 黑色軟管
- 150CM



ED-V24088BK NT\$ 650

- 蓮蓬頭
- ABS
- 黑色



ED-VS992B NT\$ 700

- 加長型三角凡而
- 304 不鏽鋼



ED-VY33019 NT\$ 760

- 三角凡而
- 銅



NEW

ED-VS995 NT\$ 700

- 控制閥三通
- 304 不鏽鋼

經典絕版



ED-VS305A NT\$ 1300

- 蓮蓬頭
- 304 不鏽鋼



ED-VS3049 NT\$ 1200

- 蓮蓬頭
- 304 不鏽鋼



ED-2013N NT\$ 950

- LED 紅外線生物光能蓮蓬頭
- W80 X H221MM
- ABS/PC

水龍頭打開後，蓮蓬頭裡面的燈光將隨之發亮。



ED-2026N NT\$ 950

- LED 七彩光蓮蓬頭
- W80 X H221MM
- ABS/PC

水龍頭打開後，蓮蓬頭裡面的燈光將隨之發亮。七彩是輪流出現白，黃，橘，紅，紫，藍，綠色彩。



ED-VS8650H NT\$ 1700

- 304 不鏽鋼
- 沖洗器
- 附 304 不鏽鋼固定座
- 附 304 不鏽鋼 150CM 加密軟管
- 附 304 不鏽鋼加長型三角凡而



8001C NT\$ 450

- 毛巾環
- TOWEL RING
- CHROME PLATING 不鏽鋼色
- W158 X D178 X H203MM
- 圓內徑 135MM



8003C NT\$ 450

- 捲筒衛生紙架 (毛巾架)
- PAPER ROLL HOLDER (TOWEL HOLDER)
- CHROME PLATING 不鏽鋼色
- W165 X D75 X H133MM



ST2291 NT\$ 950

- 書報架
- 附5000SC-2掛架固定座 厚底
- MAGAZINE RACK ACRYLIC
- 304 STAINLESS STEEL
- W320 X D100 X H230MM



1000C-2 掛桿頭 NT\$ 500 / 一對

1000CM (中通) NT\$ 250 / 一個

- 掛桿固定座
- HOLDER
- CHROME PLATING 不鏽鋼色
- BRASS 青銅材質
- φ 25 X D60MM



9009C 不鏽鋼色 NT\$ 500

- 單掛衣勾
- SINGLE ROBE HOOK
- W95 X D95MM



2303 NT\$ 780

- 捲筒衛生紙架
- PAPER ROLL HOLDER
- W175 X D80MM



1000 系列 (5 分管)

1245C 不鏽鋼色 45CM NT\$700

1260C 不鏽鋼色 60CM NT\$750

1275C 不鏽鋼色 75CM NT\$800

1290C 不鏽鋼色 90CM NT\$900

- 單桿毛巾掛桿組
- 青銅掛桿固定座 +304 不鏽鋼掛桿
- TOWEL BAR
- BRASS HOLDER
- 304 STAINLESS STEEL TUBE
- 掛桿固定座 Ø25 X D60MM (內距 40MM)



9000 系列 (1" 圓管)

9260C 60CM NT\$900

9275C 75CM NT\$1100

- 單桿毛巾掛桿組
- 青銅掛桿固定座 +304 不鏽鋼掛桿
- TOWEL BAR (HOLDER+TUBE)
- 304 STAINLESS STEEL TUBE
- 1" 圓管
- 掛桿頭 65X90MM(內距 62MM)



C2675BK 75CM NT\$1600

- 單桿毛巾掛桿組
- 黑色 BLACK
- 303 不鏽鋼掛桿固定座 + 304 不鏽鋼掛桿
- 掛桿固定座
- Ø25 X D62MM(內距 40MM)



2005BC NT\$ 530

- 附玻璃杯 GLASS CUP

2005BF NT\$550

- 附壓克力杯 ACRYLIC CUP
- 牙刷杯架
- TUMBLER CUP WITH BRASS HOLDER
- CHROME PLATING 不鏽鋼色
- W70 X D115 X H110MM
- 圓內徑 60MM



2006BF NT\$ 550

- 香皂盤架
- 附壓克力香皂盤
- SOAP DISH WITH BRASS HOLDER
- CHROME PLATING 不鏽鋼色
- W140 X D130 X H60MM



9005C NT\$ 680

- 玻璃牙刷杯架
- 附玻璃牙刷杯
- TOOTHPASTE BRUSH & TUMBLER HOLDER(SINGLE)
- CHROME PLATING 不鏽鋼色
- W75 X D125MM



9006CA NT\$ 680

- 壓克力香皂盤架
- 附壓克力香皂盤
- SOAP DISH HOLDER(SINGLE)
- CHROME PLATING 不鏽鋼色
- W140 X D145MM



2005C-R NT\$ 500

- 玻璃牙刷牙膏單杯架
- SINGLE TOOTHPASTE-BRUSH & TUMBLER & GLASS CUP W/ACRYLIC HOLDER
- CHROME PLATING 不鏽鋼色
- 壓克力座
- W160 X D112MM



2005GC NT\$ 90

- 玻璃牙刷杯
- TOOTH-BRUSH CUP
- GLASS



3506 NT\$ 550

- 香皂盤組
- SOAP DISH & ACRYLIC HOLDER
- ABS 塑膠、ACRYLIC
- W140 X D115MM



3501 NT\$ 550

- 毛巾環
- TOWEL HOLDER
- ACRYLIC HOLDER
- W200 X D80MM



3505 NT\$ 550

- 盥洗杯組
- TOOTHBRUSH HOLDER
- ABS 塑膠、ACRYLIC
- W120 X D105 X D119MM



3505A NT\$ 50

- 盥洗杯
- TOOTHBRUSH CUP
- ABS 塑膠
- W109 X D77 X H119MM



SA-05EF51-01 NT\$ 1700

- 直向長形垃圾桶
- 430 不鏽鋼桶身 (厚度 0.4MM)
- 緩降腳踏式
- DUSTBIN
- 容量：5L
- W163 X D280 X H287MM
- 塑膠內桶
- W163 X D216 X H236MM



V1007L NT\$ 2400

- 電子感應自動環保桶 - 直向
- ABS 白色
- AUTO SENSITIVE DUSTBIN
- 縱向上掀
- 容量：7L
- W150 X D230 X H310MM
- 附 3 號電池 X 2

※ 出清商品，依現有庫存售完為止，恕不再另行公告通知

經典絕版



M-1195 NT\$ 5600

- 雙層易潔鏡 (可橫、直掛)
- MIRROR
- W680 X H480MM



M-526 NT\$ 4100

- 雙層防霧鏡 (可橫、直掛)
- MIRROR
- W480 X H680MM

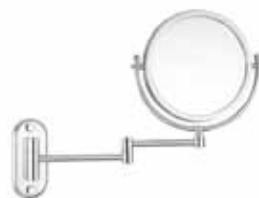

1006W NT\$ 3200

- 壁掛式雙面伸縮鏡
- CHROME PLATING不鏽鋼色
- 伸縮桿為青銅材質
- 底座為 304不鏽鋼
- REVERSIBLE WALL-EXTENSION MIRROR
- 鏡面 Ø190MM
- 伸縮長度：一段175MM 二段330MM
- 平面·放大 (放大兩倍)



1006SC NT\$ 2000

- 桌上型明鏡
- PORTABLE MIRROR
- CHROME PLATING 不鏽鋼色
- BRASS 青銅材質
- W165 X D110 X H300MM



ST3088C NT\$ 1350

- 單層紙巾架 活動式
- SINGLE ACTIVE TOWEL RACK
- 304 STAINLESS STEEL
- W280 X D165 X H290MM



ST3026T NT\$ 650

- 桌上型砧板架
- CARVING BOARD STAND
- 304 STAINLESS STEEL
- W155 X D123 X H120MM
- 砧板厚度 30 / 30MM



2003CL NT\$ 800

- 壁式紙巾架
- PAPER TOWEL HOLDER
- CHROME PLATING 不鏽鋼色
- BRASS 青銅材質
- W250 X D70 X H105MM
- 內徑 230MM



ST5218 NT\$ 950

- 活動衣褲架
- 304 STAINLESS STEEL
- W450 X D110 X H40MM



ST3033 NT\$ 2100

- W320 X D320 X H280MM

- 轉角架-掛式
- CORNER RACK
- 304 STAINLESS STEEL



ST3033DH NT\$ 3200

- 雙層轉角架
- 適合廚房用
- 附5000SC-2掛架固定座 厚底
- CORNER RACK DOUBLE
- 304 STAINLESS STEEL
- W320 X D320 X H340MM
- 內徑高度 190MM



3312SCG NT\$ 1200

- W200 X D200MM

3312CG NT\$ 1350

- W310 X D310MM
- 轉角架 附圍欄
- 附 3300C-2 固定座 / 一對
- 8MM GLASS CORNER HOLDER WITH 3300C-2 HOLDER
- 8MM OG 邊強化玻璃



ST3076 NT\$ 4900

- 水槽上方置物組
- 附插盤架、餐具桶
- 可另選購滴水盤3061-30 x 2
- SINK MULTI-PURPOSE RACK
- 304 STAINLESS STEEL
- W712 X D250 X H440MM (內徑W685 X H355MM)



ST3076S NT\$ 3250

- 水槽上方置物架
- 可另選購滴水盤3061-30 x 2
- SINK MULTI-PURPOSE RACK
- 304 STAINLESS STEEL
- W712 X D250 X H440MM (內徑W685 X H355MM)



9850-01 NT\$ 900

- 烘碗機網架 (80cm)
- 附小碗架 X1+ 筷子盒
- 304 STAINLESS STEEL
- W745 X D280 X H270MM
- 烘碗機內用小碗架
- 304 STAINLESS STEEL
- W285 X D130 X H75MM

9850-02 NT\$ 650

- 烘碗機網架 (80CM)
- 附 1003 ABS 筷子盒
- W745 X D280 X H270MM



3012LC 不鏽鋼色 NT\$ 500

- 吊杯架 (大)
- HANGING CUP RACK L
- CHROME PLATING
- BRASS 青銅材質
- W360 X D60MM



D5300-2

- 前托架及卡夾頭
- FRONT BRACKET WITH DOWEL

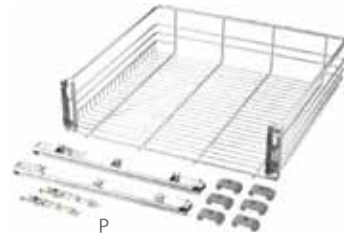

抽屜式三邊拉籃

- DRAWER TYPE
- P (鍍鉻) 三段式鋼珠滑軌



抽屜式拉籃

- DRAWER TYPE

抽屜式三邊拉籃
SLIDING BASKET (DRAWER TYPE)

CABINET WIDTH 櫥櫃尺寸	ITEM NO.	DIM. WDXDH(MM) 拉籃尺寸
	304 STAINLESS STEEL+CHROME 不鏽鋼 + 鍍鉻	
400MM	ST5340P NT\$2900	320X483X140
450MM	ST5345P NT\$3000	370X483X140
500MM	ST5350P NT\$3200	420X483X140
720MM	ST5372P NT\$3600	640X483X140



3012SC 不鏽鋼色 NT\$ 400

- 吊杯架 (小)
- HANGING CUP RACK S
- CHROME PLATING
- BRASS 青銅材質
- W300 X D60MM



ST3037 NT\$ 300

- 鍋蓋架
- 304 STAINLESS STEEL
- W95 X D87 X H280MM



開放式四邊拉籃

- OPEN DOOR TYPE
- PZ (鍍鉻) 三段式鋼珠滑軌



開放式四邊拉籃
SLIDING BASKET (OPEN DOOR TYPE)

CABINET WIDTH 櫥櫃尺寸	ITEM NO.	DIM. WDXDH(MM) 拉籃尺寸
	304 STAINLESS STEEL+CHROME 不鏽鋼 + 鍍鉻	
400MM	ST5440PZ NT\$2800	275X475X120
450MM	ST5445PZ NT\$2900	325X475X120
720MM	ST5472PZ NT\$3200	595X475X135
1000MM	ST5400PZ NT\$3900	875X475X135



ST3038 NT\$ 550

- 砵板掛架
- 304 STAINLESS STEEL
- W410 X D110 X H350MM

※ 出清商品，依現有庫存售完為止，恕不再另行公告通知



營造現在舒適生活空間，必定伴隨著良好的收納設計。
DAY&DAY以人性為設計的價值，以機能性、高品質、極簡美感為設計理念，設計製造出貼近使用者的不鏽鋼生活用品。
DAY&DAY以藍色基調，象徵水-生命的必需品，與生活不可分離的關係。

DAY&DAY 日日家居生活精品
www.daynday.com.tw