

*Brand.
Collections.
Programmes.
Axor Manufaktur.
References.*

The entire *RANGE* of **Axor** products **online.**

Interactive catalogue

You are now able to access the Axor product range with your tablet or smartphone. Simply use the "shortcut" app and follow the next steps to access a new digital dimension.



1. Download the free "Shortcut Reader" app from the App Store or Google Play Store on to your smartphone/tablet and activate the app by clicking on it.



2. Point your smartphone/tablet at any page in this catalogue and photograph it or scan it in.



3. Via the link, you can see a complete overview of the product range and more detailed product information. You can also find out more about Axor's design partners and the inspiration behind each collection. Or you can click your way through Axor's project references and discover much more about the Axor brand.



The interactive link to the Axor catalogue only works as long as this Axor application is activated.

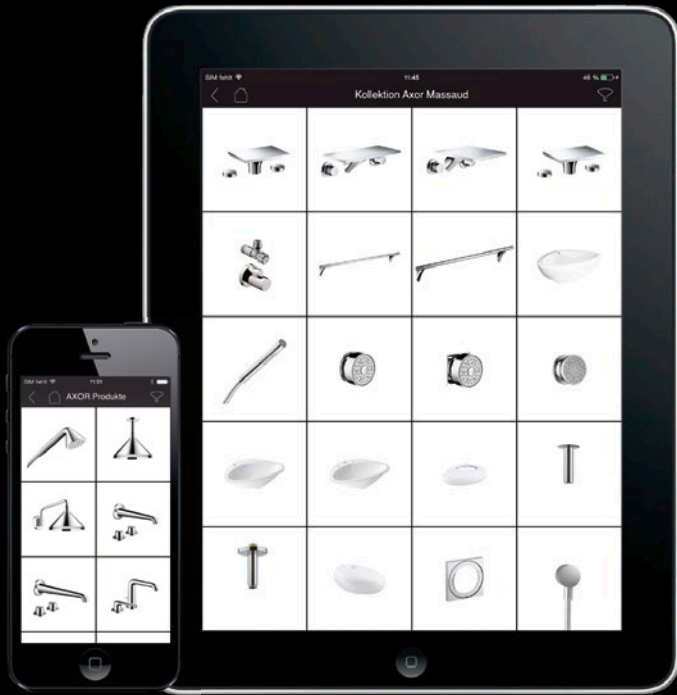

The Axor App can be downloaded from the App Store.

Axor App

The Axor App gives users an overview of the exclusive Axor bathroom products, references and designers – on their mobile or tablet, quickly, easily and free of charge. The product overview gives a complete picture of each product through comprehensive information and alternative product options together with technical and inspirational images.

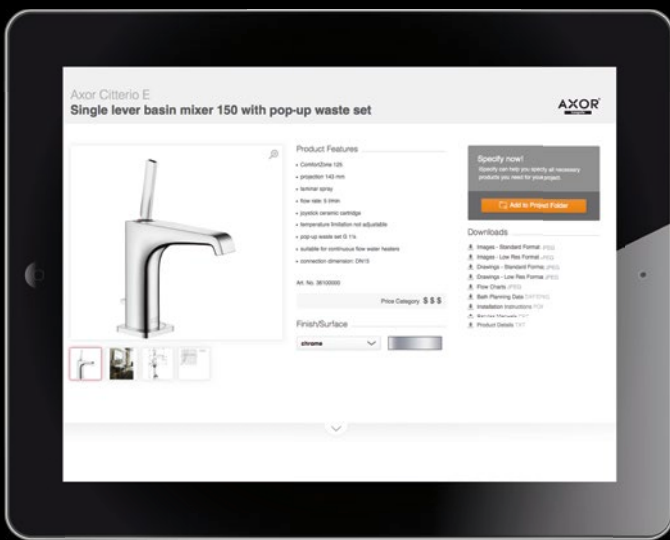

You can find iSpecify at ispecify.hansgrohe.com

iSpecify

iSpecify is the online tool for architects and interior designers. It can be used to plan and complete projects efficiently: specifications can be configured conveniently, product data is collated, technical data and drawings are downloaded. Inspiration can be found in a broad spectrum of international reference projects including hotels, private houses, construction projects and luxury yachts.



Water is
PRICELESS.



Axor sees itself as an *ambassador* for the union of *people, space and water*. In this spirit, we and our designers create unique *design objects* that help to make the bathroom a *very special place*.

Philippe Grohe, Head of Axor brand

Having many different **perspectives ...**

From the very beginning, Axor has developed collections and products based on a single overriding vision: to see bathrooms through the eyes of the world's best designers and architects. Their view of the world, their philosophy, their cultural background and their creativity – all of this should form the basis for the collections. Axor works in collaboration with some of the most creative minds of our time developing their ideas into a beautiful and functional reality.

*... allows you to
see so much **more.***

This is why Axor takes its own unique approach to developing its products, cooperating with design partners who fuse modern concepts with timeless aesthetics. The starting point is often the Axor WaterDream, a joint project with designers which – much in the same way as a concept car in the motor industry – seeks out innovative solutions for the bathroom of the future.



"We always aim to add something more *unexpected* to a project."

Front



"WE TRY VERY HARD TO SEARCH FOR A NEW ARCHETYPE FOR EVERYDAY ITEMS: A NEW WAY OF LOOKING AT SOMETHING FAMILIAR."

Edward Barber and Jay Osgerby



"It's my belief that design can arouse genuine feelings in people."

Jean-Marie Massaud



"I DO BELIEVE THAT INNOVATION TODAY COMES NOT IN TERMS OF FORMS BUT RATHER IN TERMS OF PRODUCT PHILOSOPHY."

Antonio Citterio



"Good design is when I can explain my idea to my grandmother or to a small child."

Nendo

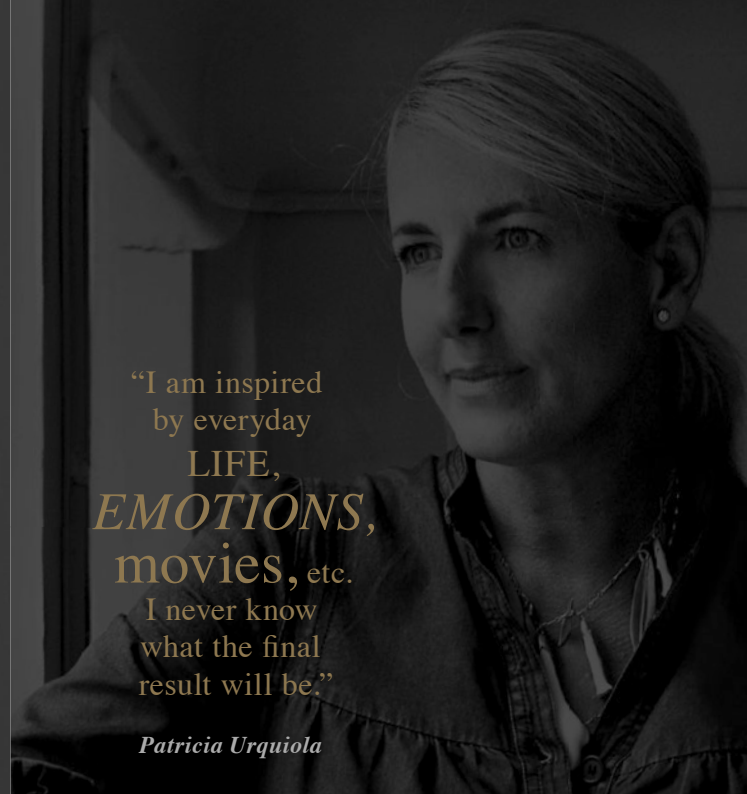

"I am inspired by everyday LIFE, **EMOTIONS**, movies, etc. I never know what the final result will be."

Patricia Urquiola



"**LOGIC**, morals and magic are the basic values of a successful **DESIGN**."

Andreas Haug, Phoenix Design



"We like the idea of letting the user decide how to use an object."

Ronan and Erwan Bouroullec



"A designer's role is to create **MORE** happiness with *less*."

Philippe Starck

SOPHISTICATION

can also be *revealed* in that which

is **concealed.**

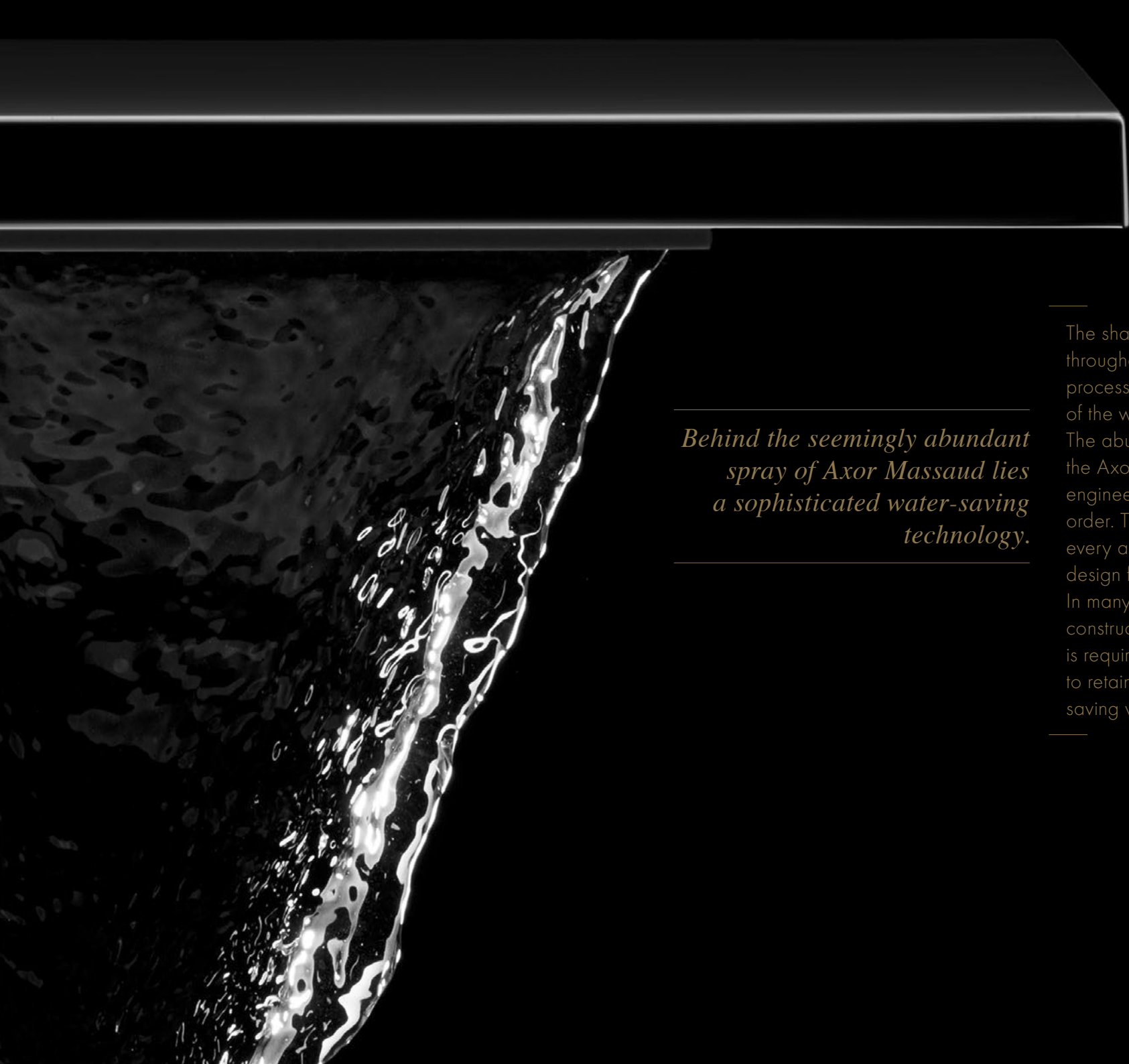

*Behind the seemingly abundant
spray of Axor Massaud lies
a sophisticated water-saving
technology.*

The shape of the mixer evolves throughout an intensive design process – and with it the design of the water that flows from it. The abundant water spray from the Axor Massaud mixer conceal engineering skill of the highest order. The water specialists explore every avenue until function and design form a harmonious whole. In many cases, an innovative construction of the inner workings is required in order for the stream to retain its unique aesthetic while saving water at the same time.

Individuality

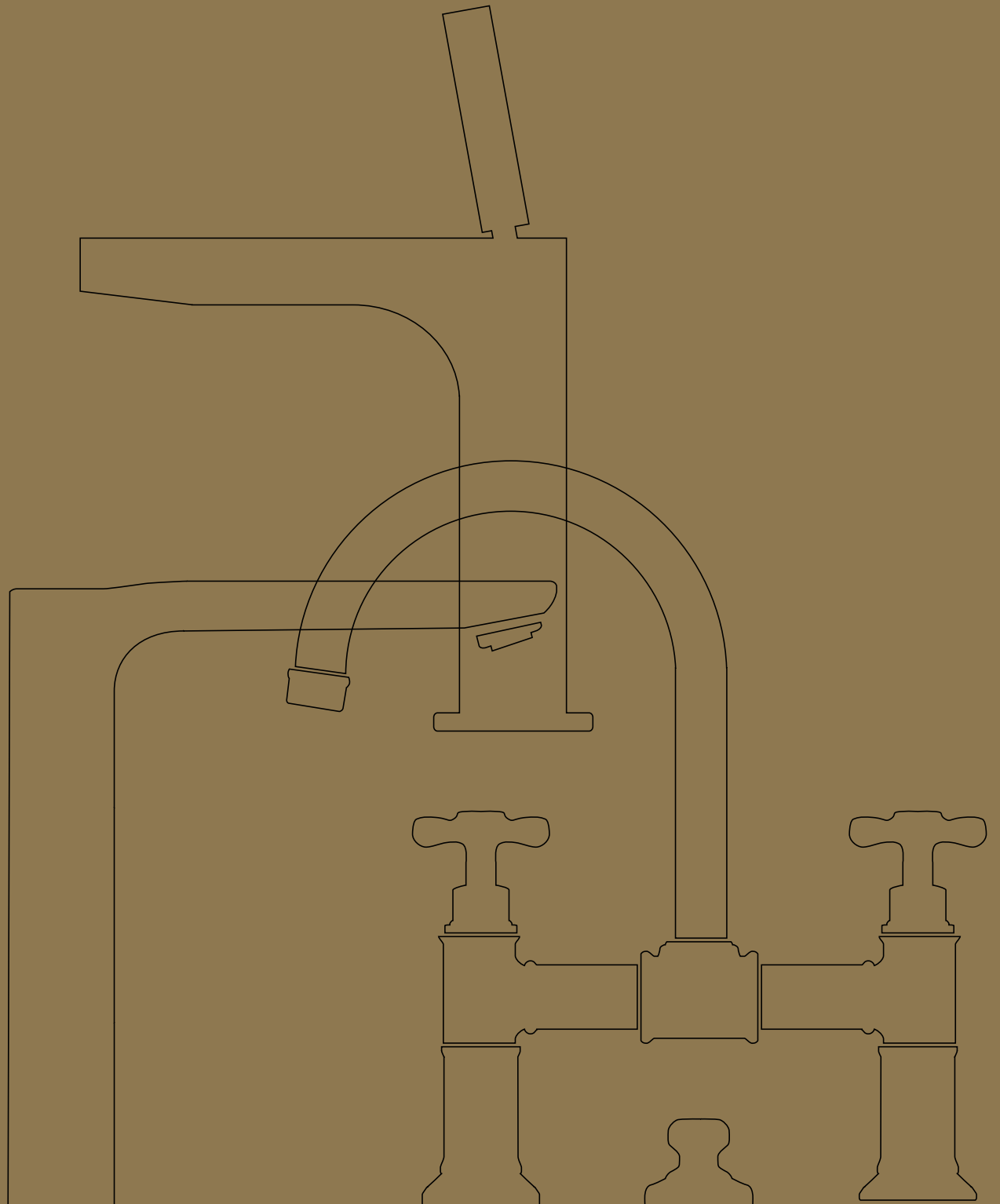

in *EXPRESSION.*

Never before has it been so easy to design an unforgettable bathroom. The variety of design styles, the diverse design language, extensive collections in perfect harmony - all of this helps to make individual wishes a reality. But when a touch more individuality is required, special wishes are - literally - in the best of hands with Axor Manufaktur. Here, where Axor products are manufactured, the resident experts meet these bespoke wishes with pure craftsmanship, never failing to convey a sense of quality, personality and uniqueness.



Collections.

An Axor collection consists of mixers and showers, wash basins, bathtubs and accessories – all of consistent design. Here, Axor's design partners lend the collections their own particular character. Discover the sheer diversity of styles in the Axor collections.

	Axor Starck.	14–23
	Axor Starck V.	24–27
	Axor Starck Organic.	28–39
	Axor Citterio.	40–51
	Axor Citterio E.	52–63
	Axor Citterio M.	64–75
	Axor Urquiola.	76–87
	Axor Massaud.	88–99
	Axor Bouroullec.	100–109
	Axor Uno ² .	110–115
	Axor Carlton.	116–121
	Axor Montreux.	122–129

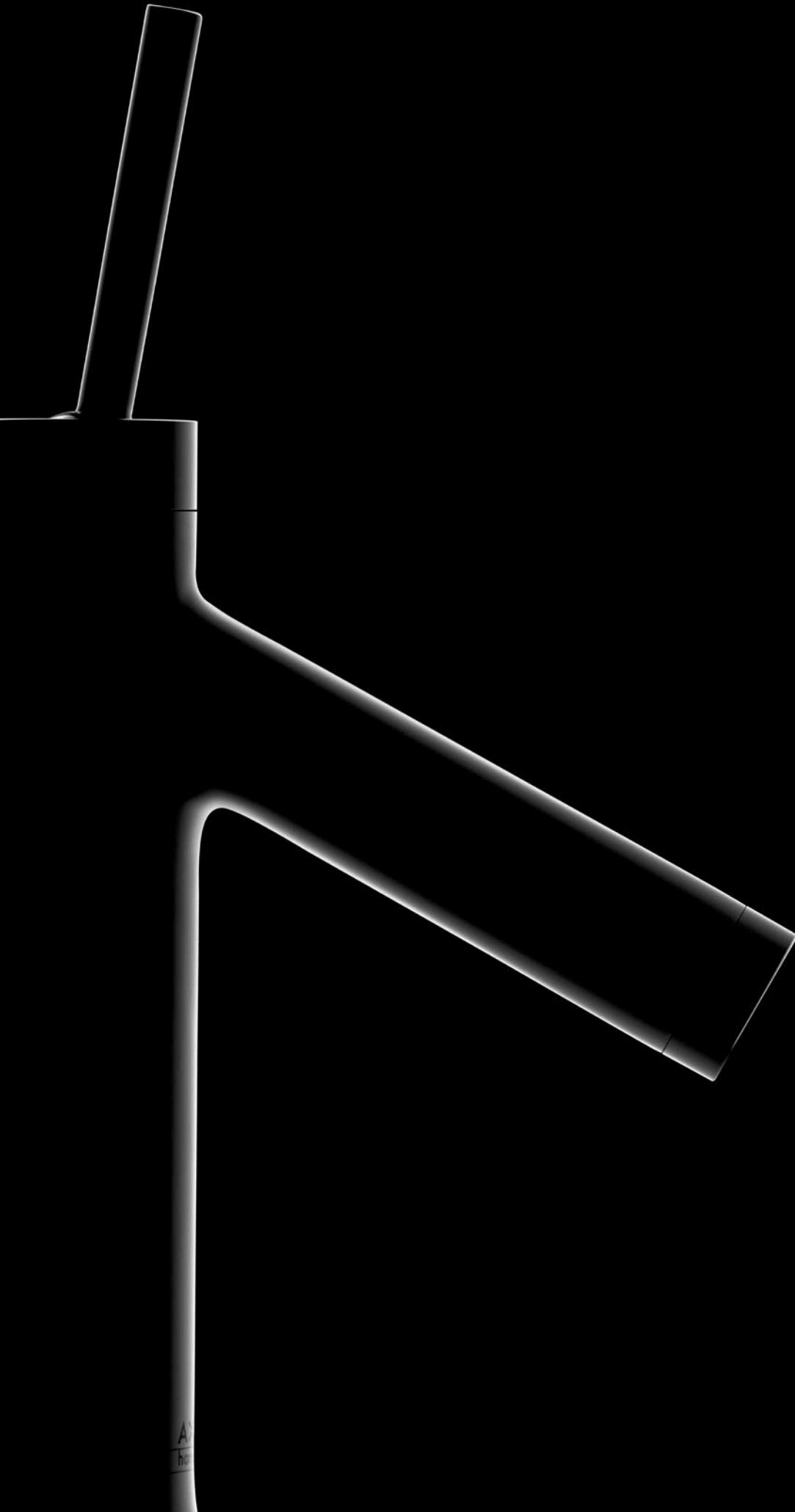



Axor Starck

The aesthetics of minimalism

An enduring bathroom collection that will survive the whims of fashion. Like an ancient well, Axor Starck draws water from the depths below. Creating a bathroom that exudes peace and relaxation. The Axor Starck collection focuses on the basics: the pure pleasure of water. The reduction principle is reflected in its purist forms and clear functions, with nothing to distract the eye.



Further Axor Starck products and information
can be found on our website.





The Axor Starck X mixer takes minimalism to the max: the square plate appears to float weightlessly, releasing water in the form of a flood spray.





Axor Starck stands out through its consistently geometric forms: be it the two-handle mixer, the three-hole wall-mounted basin mixer or the matching accessories.

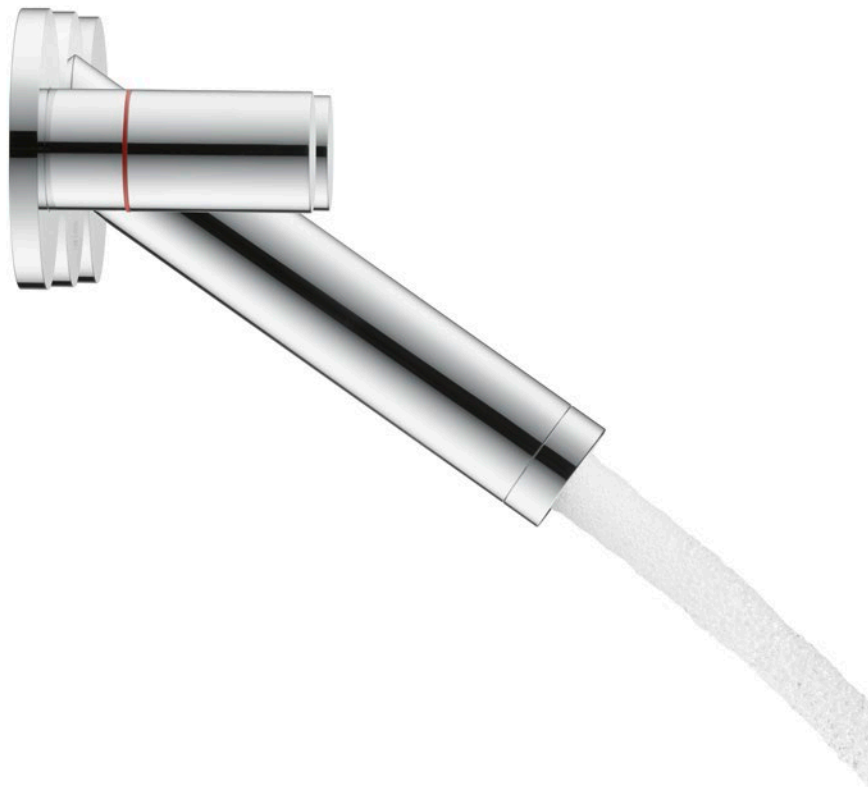

With its diagonal spout, the archetypal single lever mixer bears a close resemblance to a water pump. The purist design is free of all clutter.





The shower set with hand shower focuses on the basics - functionality with no distractions.





The aesthetics of reduction: the clear, timeless shower column looms majestically.



Axor Starck V







Vitality of **Water**

Axor has always been driven by a boundless curiosity and a passion for water. The pure energy of a *vortex* never fails to impress. How can the essence of this spectacle of nature be transported to the wash basin? Axor Starck V brings the full force of nature to the fore with an *organically sculptural* glass mixer. The glass body allows the elegant vortex to be seen in all its glory. If no water is running, the crystal glass mixer becomes a well in everyday life.



Further Axor Starck V products and information can be found on our website.



With its various options, Axor Starck V lends the bathroom a sense of individuality. For instance, its *porcelain* and *glass* spouts help to create a simple yet modern elegance. The timeless look is further accentuated when combined with *white* or *chrome* bases. In order to fit into classic ambiances, Axor Starck V comes with fine diamond or bevel cuts and with bases in gold optic or rose gold, which are produced exclusively in Axor Manufaktur.



Axor Starck Organic





Follow
your
Head
and
your
Heart

Axor Starck Organic is a collection that appeals to the heart and intellect in equal measure. With this highly innovative **mixer shower spray**, you can enjoy a sensual water experience while saving water at the same time. The *organic, minimalist* design shapes the complete collection with its natural, *lively* forms and fluid transitions.



Further Axor Starck Organic products and information can be found on our website.





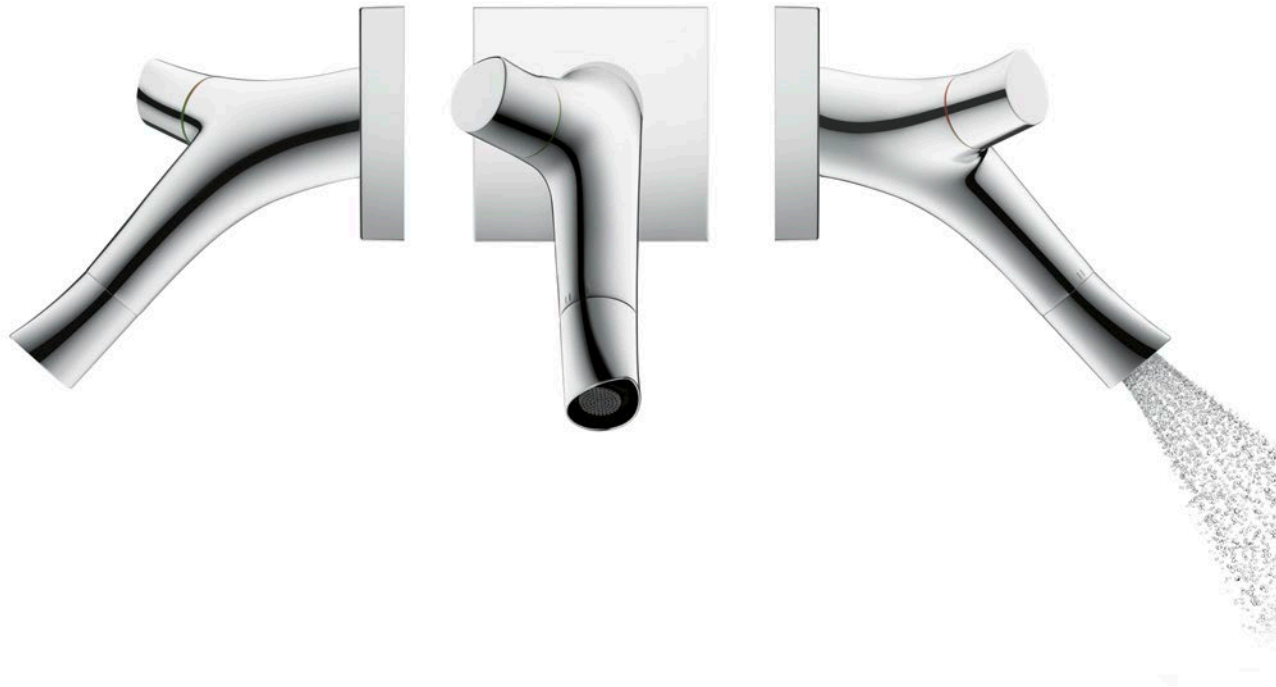

The **revolutionary operating concept**, with separate temperature and water volume control and the economical rate of **3.5 l/min** makes us more aware of the need to preserve the vital resource that is water.



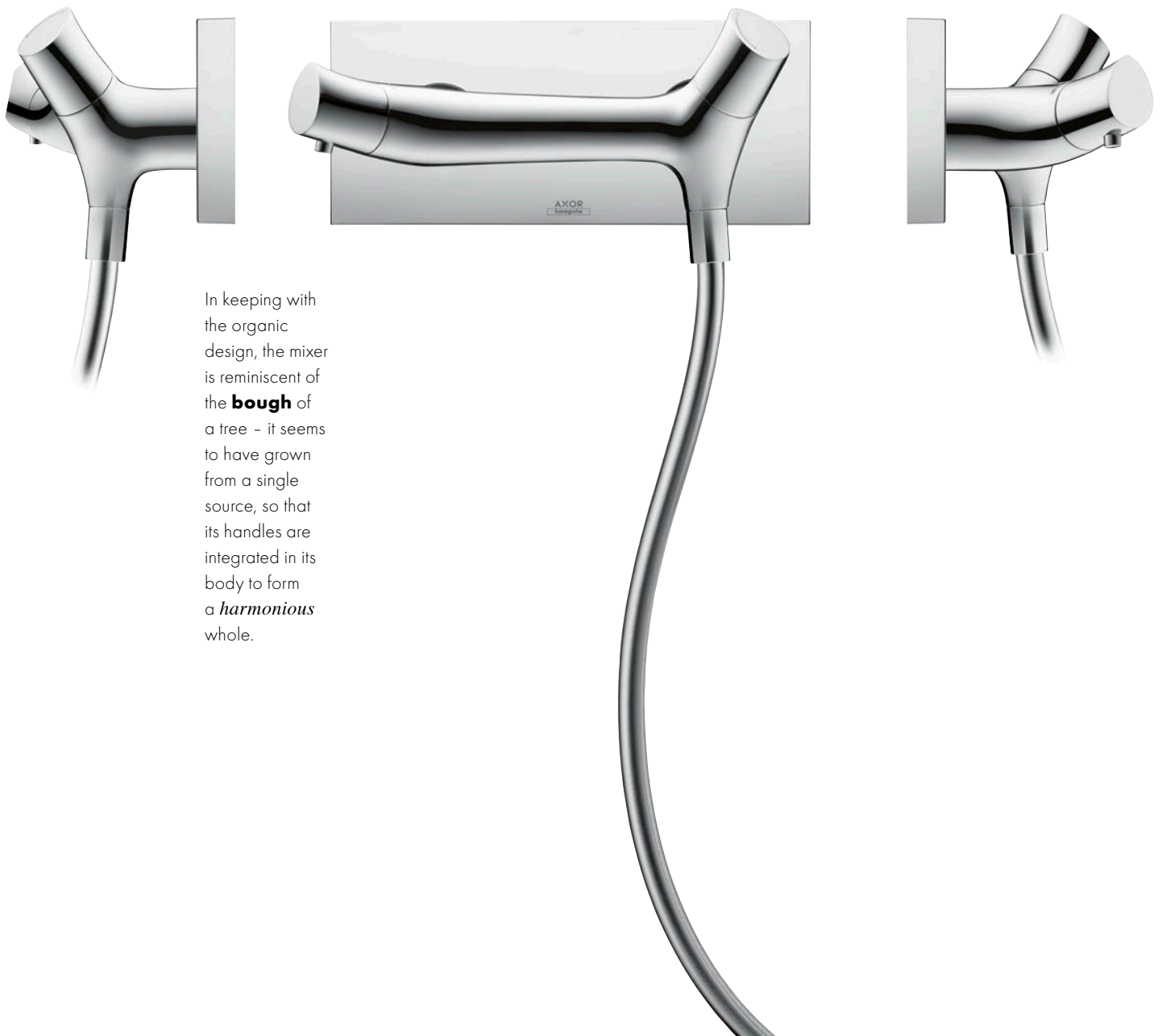

In keeping with the organic design, the mixer is reminiscent of the **bough** of a tree - it seems to have grown from a single source, so that its handles are integrated in its body to form a *harmonious* whole.







Organic spouts and handles combine with **angular** escutcheons to form a stimulating design - whether as a sculptural floor-standing or concealed-installation thermostat.





Axor Citterio

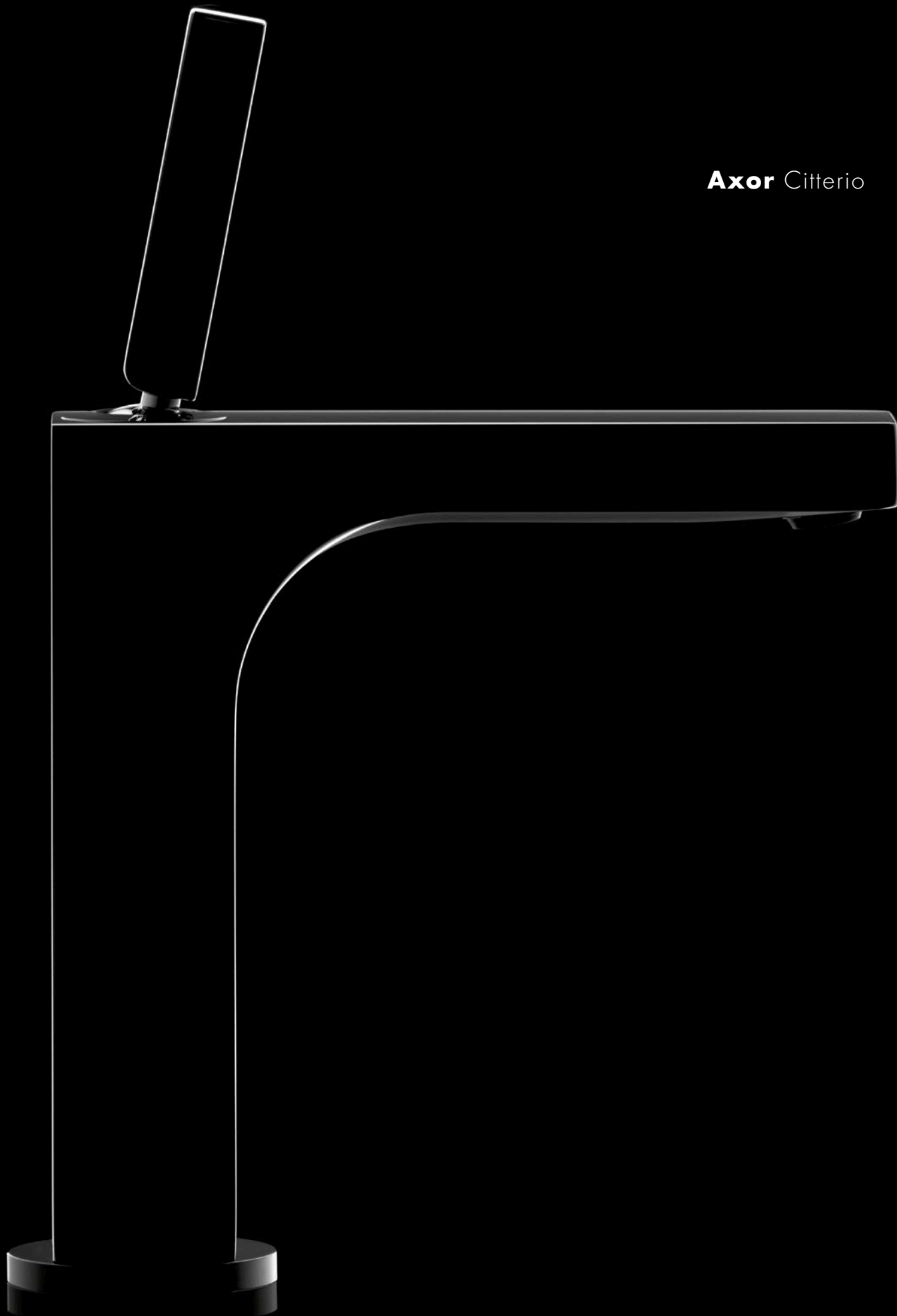

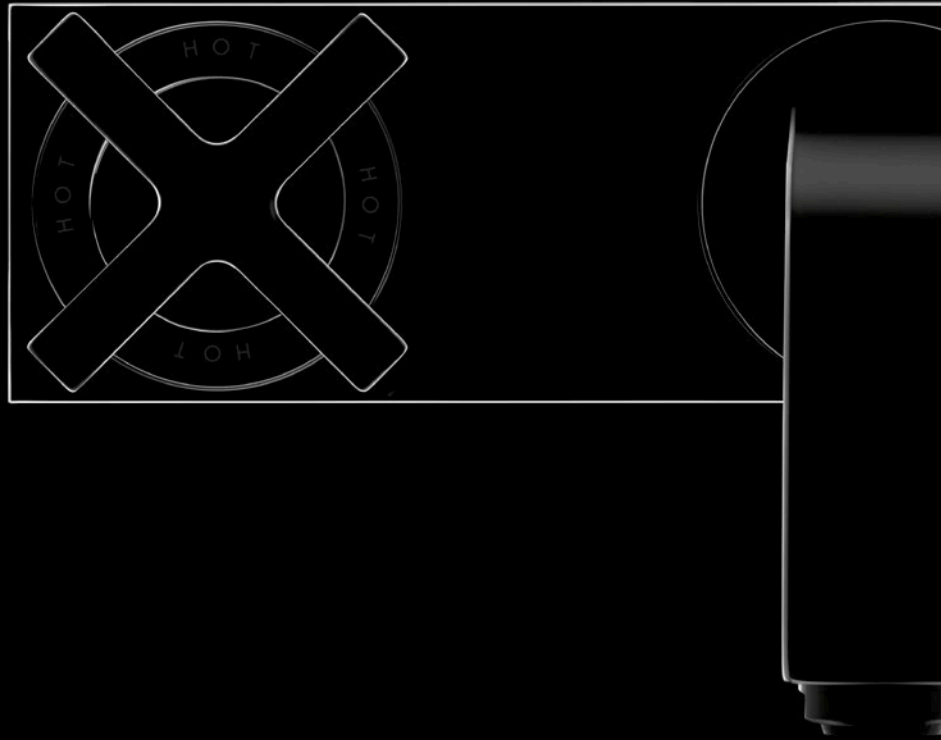





LUXURY AT A SECOND GLANCE

With its precisely formed surfaces and edges in which light refracts and reflects and a whole host of rich details that reveal themselves on second glance, Axor Citterio allows us to make the most of the time we spend in the bathroom. A classically elegant collection that celebrates above all the part played by water in our everyday lives.



Further Axor Citterio products and information can be found on our website.



The basin mixer is distinguished by the harmonious combination of round and angular elements. The gentle curves follow the flow of the water and bow down to it with supreme elegance. The design of the handle, with which the mixer can be turned on and off, helping users to conserve water.

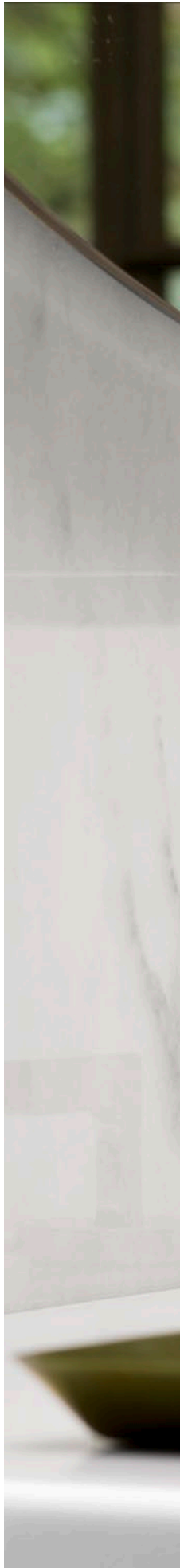





The self-cleansing ritual is actively cultivated in the shower, with an innate luxury that only truly reveals itself on second glance.





The elegant, simple cross handles of the fittings call to mind 1930s Italian architecture and lend the bathroom a timeless elegance.







Axor Citterio E

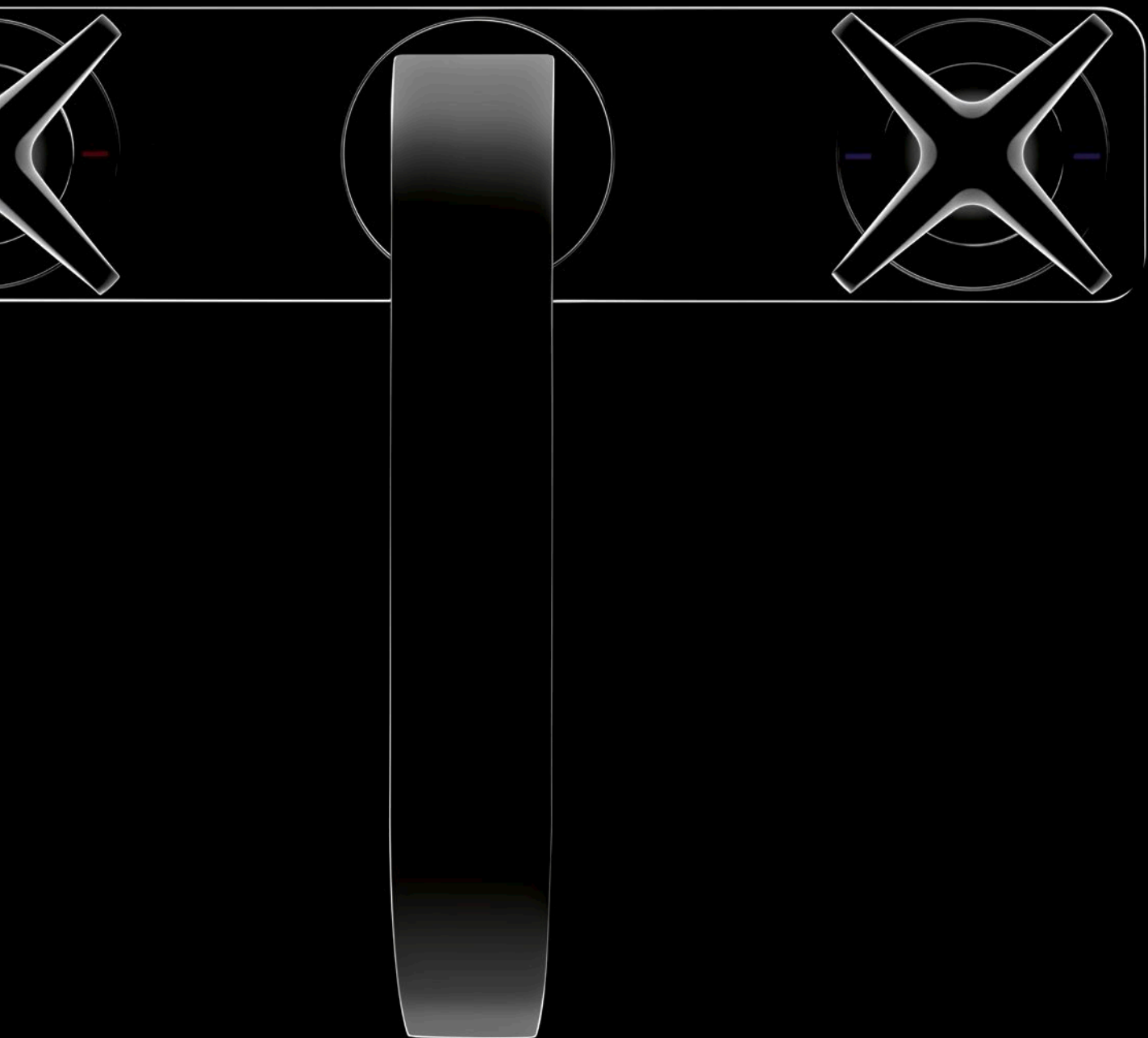







The **ESSENCE** of *Luxury*

The charm of Axor Citterio E lies in the combination of new and familiar elements, the marriage of *classic appeal* and modern functionality. This perfectly formed collection combines **timeless quality** with a refined elegance, celebrating the everyday use of water and making it into something truly special. A collection for wash basins, shower and bathtub which, with its timeless design, is in its element in both classic or modern ambiances.



Further Axor Citterio E products and information can be found on our website.



How can the value of water be reflected? With **precisely** formed edges and surfaces which, together with *gentle curves*, create a soft, harmonious feel - included in its various handle options. Is there a more pleasurable way to use a mixer?









The scope for *individual* design is almost boundless: the thermostat module can be installed with individual escutcheons or with a plate. With a matching elegant, functional shower set with double rail.



With the four-hole or floor-standing thermostat, the *elegant* luxury can also be extended to the bathtub.

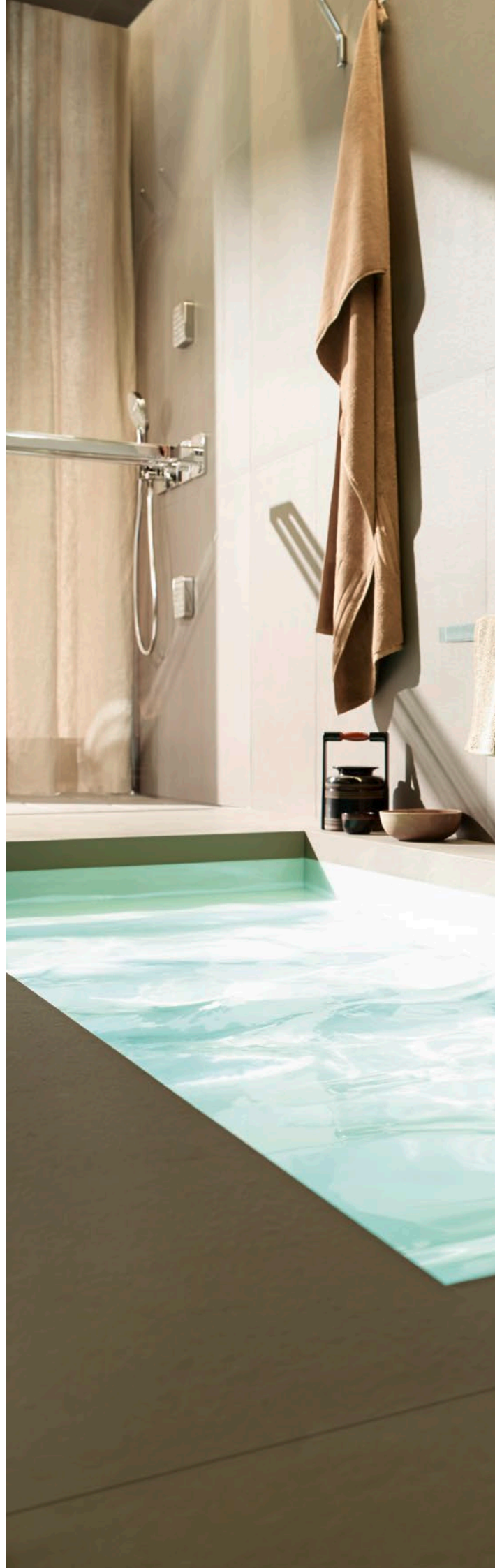









Axor Citterio M



URBAN CHIC



How about a bathroom collection that is inspired by modern city life? That exudes the artistry of timelessly modern design? Axor Citterio M is characterised by its distinctively reduced and slim forms and an elegant overall look - a collection that, with a unique lightness but a striking design, fits perfectly in a contemporary lifestyles.







What makes an especially ergonomic handle design? The shape is a combination of high-quality finishes and smooth curves, allowing the handle to fit snugly in your hand.







With its slim, reduced form, the showerpipe exudes timeless urbanity.





Elegance across the board: the simple, reduced bath mixers also fit with the striking design of the bathtub.











Axor Urquiola



Awakening your *senses*

A bathroom collection

*that awakens our senses. Axor Urquiola
conjures up a **MIXTURE**
of various **STYLES:**
gentle curves **fusing** with asymmetries
and large surfaces. Each element
has its own **CHARM**, all merging
together into a **multifaceted**
whole. The archetypal shape of the wash bowl
and bathtub call to mind old-style washtubs.
Axor Urquiola is a **SENSUAL**,
imaginative collection,
right down to the very last detail.*



Further Axor Urquiola products and
information can be found on our website.





AXOR
hansgrohe



The elegant **HANDLES** of the Axor Urquiola mixers
are extremely comfortable to use thanks to their **OPEN**
DESIGN.

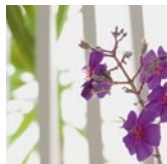
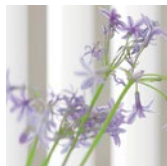
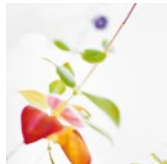



With its
asymmetrically
arranged elements, the Axor Urquiola
shower column looks like an
organic product
of nature.







Nostalgic bathing pleasure in the washtubs of today.





Axor Massaud





Nature inspired design

Water

is the
source
of
all

life.

Which
is why
Axor Massaud
is in
complete
harmony
with

nature.

The
flood
spray
becomes

a *waterfall.*

The
towel
rack

a *bough.*

The
tub

a *lake.*

This
lavish
collection
allows
us
to

experience
the
element
of water
in all
its

sensual

glory.

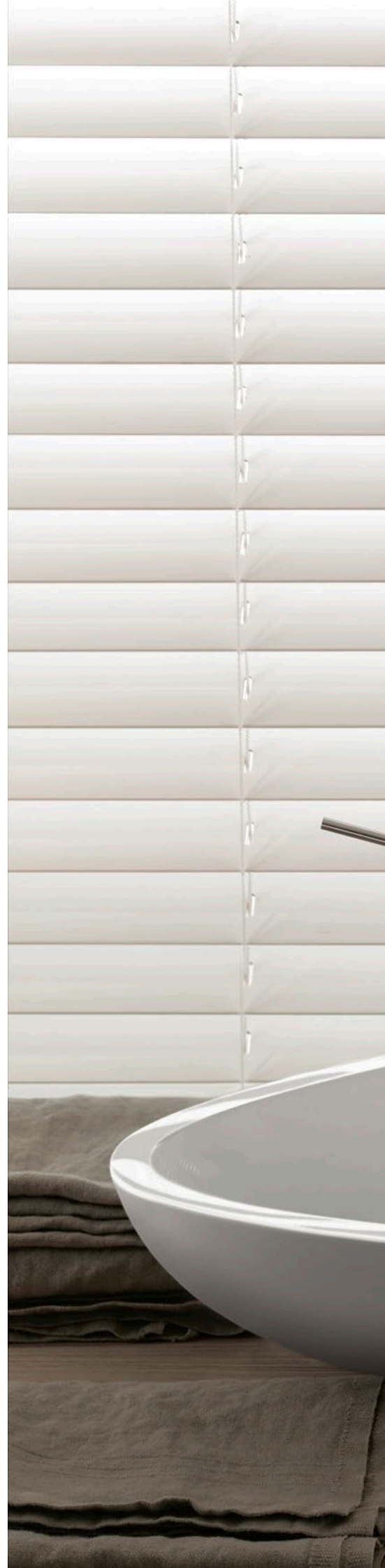



AXOR
Massaud





As
with
the
flood spray,
the
organically
designed
accessories
both
refer
to
and
celebrate
nature:
the
vase,
candle
holder
and
toothbrush
tumbler
are
all
inspired
by
the
shape
of
a *pebble*.





Axor Massaud
combines
*gently
curved*
lines
and
clear
geometric
surfaces
in a
*harmonious
design
language.*

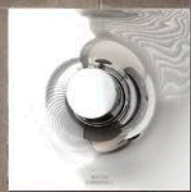

The
archetypal

mixer
on
the
bathtub
and
the
wash
basin
is not
only
exceptional
and

sculptural

in
appearance -
it is
also a

well-proportioned

shelf

for
holding
toiletries.









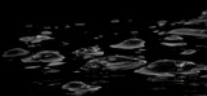
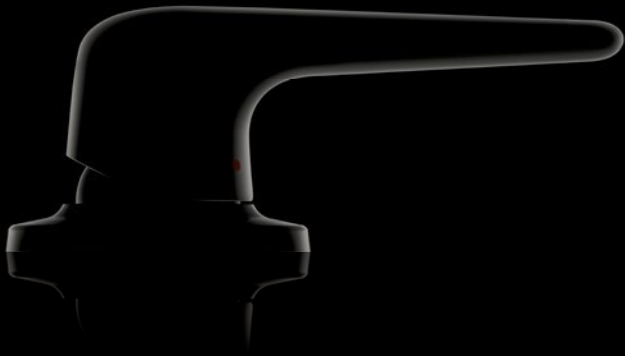
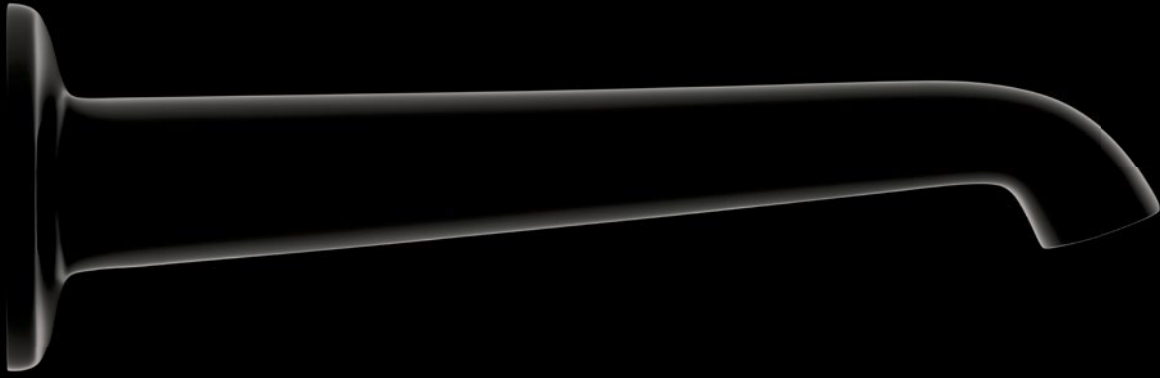

Axor Bouroullec



Everything flows

Axor Bouroullec is the epitome of restraint and is held in particularly high esteem by minimalists. The organically minimalist design remains low key at all times. The products blend harmoniously with any style. Additional space is offered by the gently shaped shelves that are integrated in the wash basin, shower and bathtub products.



*Further Axor Bouroullec products and information
can be found on our website.*





The freedom to design freely:

The minimalist design with the tapering spout can be seen in the wall-mounted version and the standing mixer for wash bowls.





Ample room for toiletries:

Thanks to the space-saving shelves
or the integrated shelf area on the
Showerpipe.





Two shelf areas on the bathtub allow users to choose for themselves where to position the mixer elements.







Axor Uno²

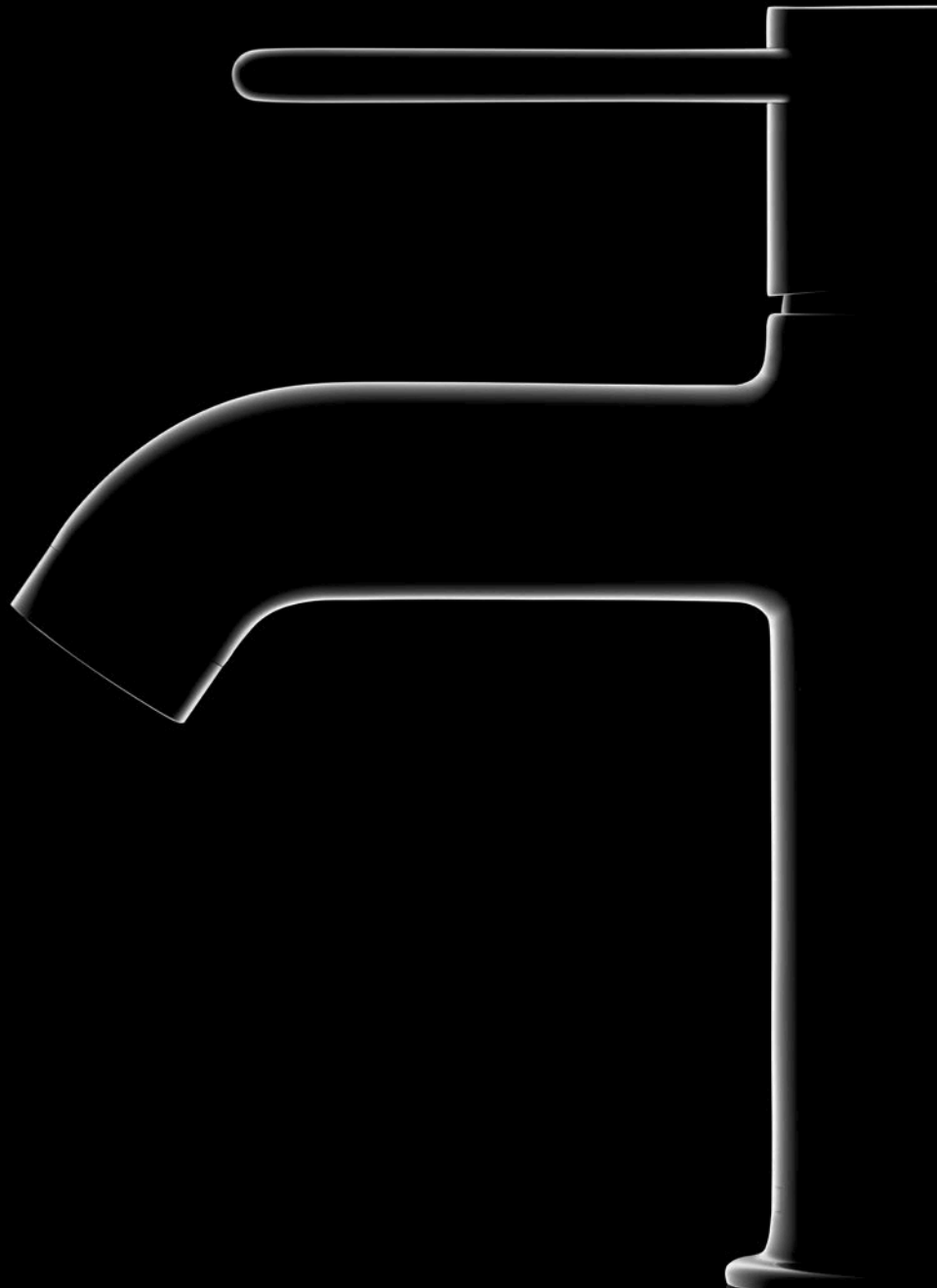



Further Axor Uno² products and information
can be found on our website.



The classic minimalist

At the heart of the unobtrusive style of the Axor Uno² mixer collection is a clear geometric design founded on simple, cylindrical basic shapes. This allows it to blend in with any bathroom ambience.





Timeless modern shapes and the striking bow-shaped handle are just the thing for anyone who appreciates linear design.





Axor Carlton



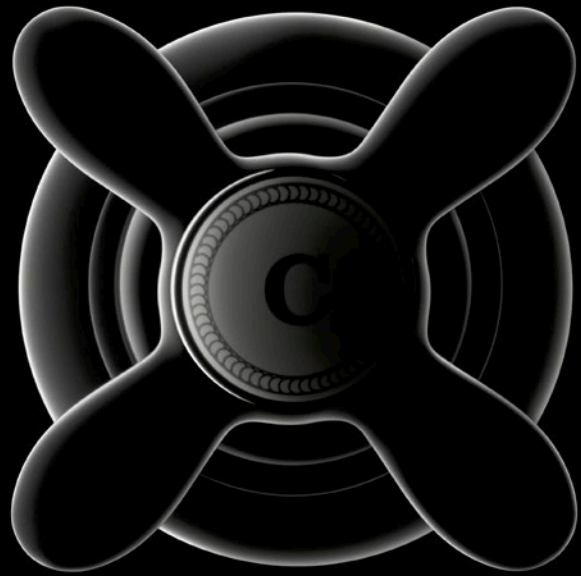

A homage to the golden 20s





With its sweeping shapes, Axor Carlton is reminiscent of the days of the glamorous grand hotels of the 1920s. The opulent handle options are particularly striking. A nostalgic collection that will outlive any trend.



Further Axor Carlton products and information can be found on our website.



In the shower, classic design meets the modern comfort of a thermostat: traditional lever handles, stylish cross handles and the curved arm of the overhead shower combine to create a nostalgic effect. Also characteristic are the little porcelain plates bearing the traditional "H" and "C".





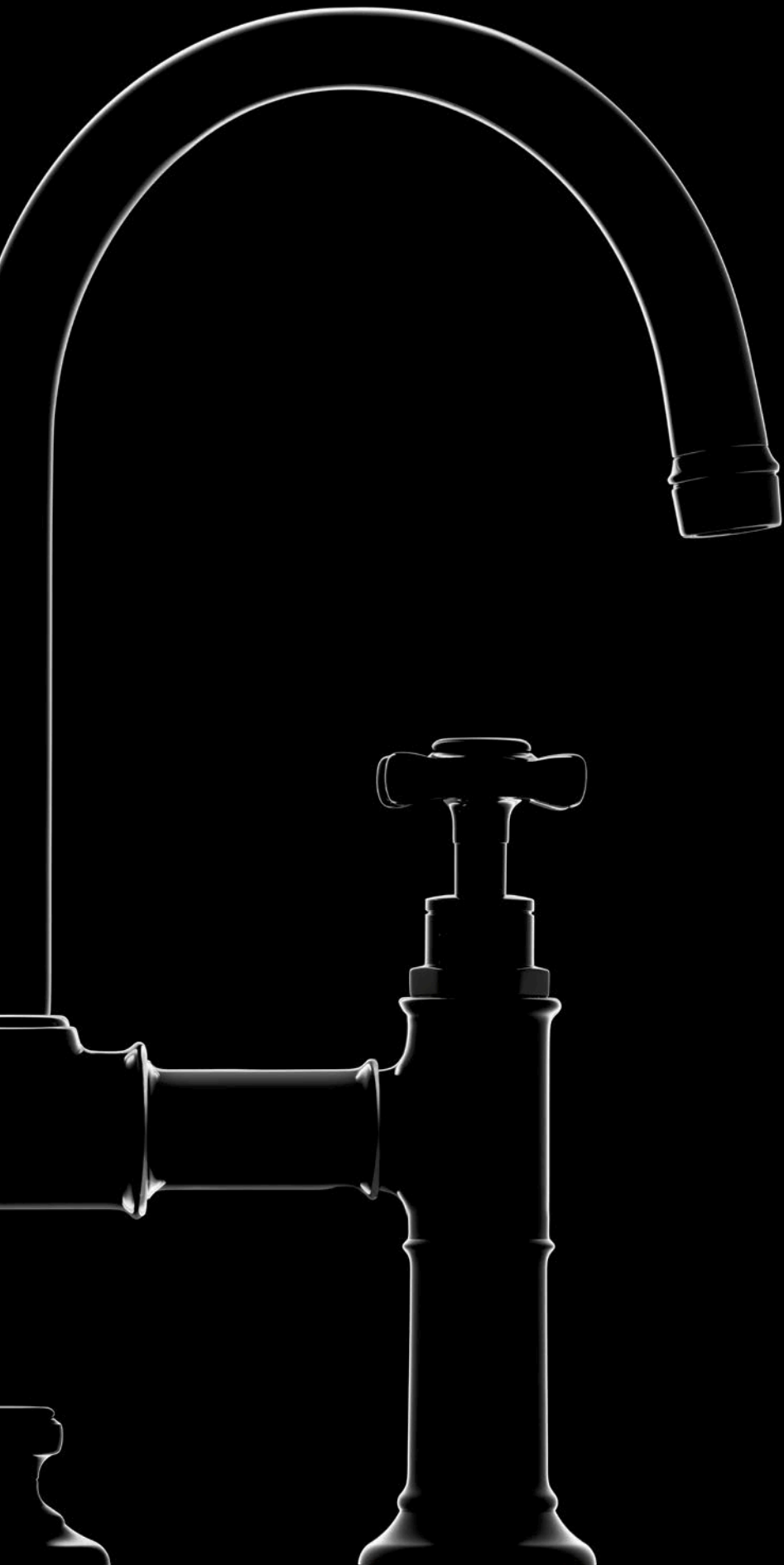

Axor Montreux

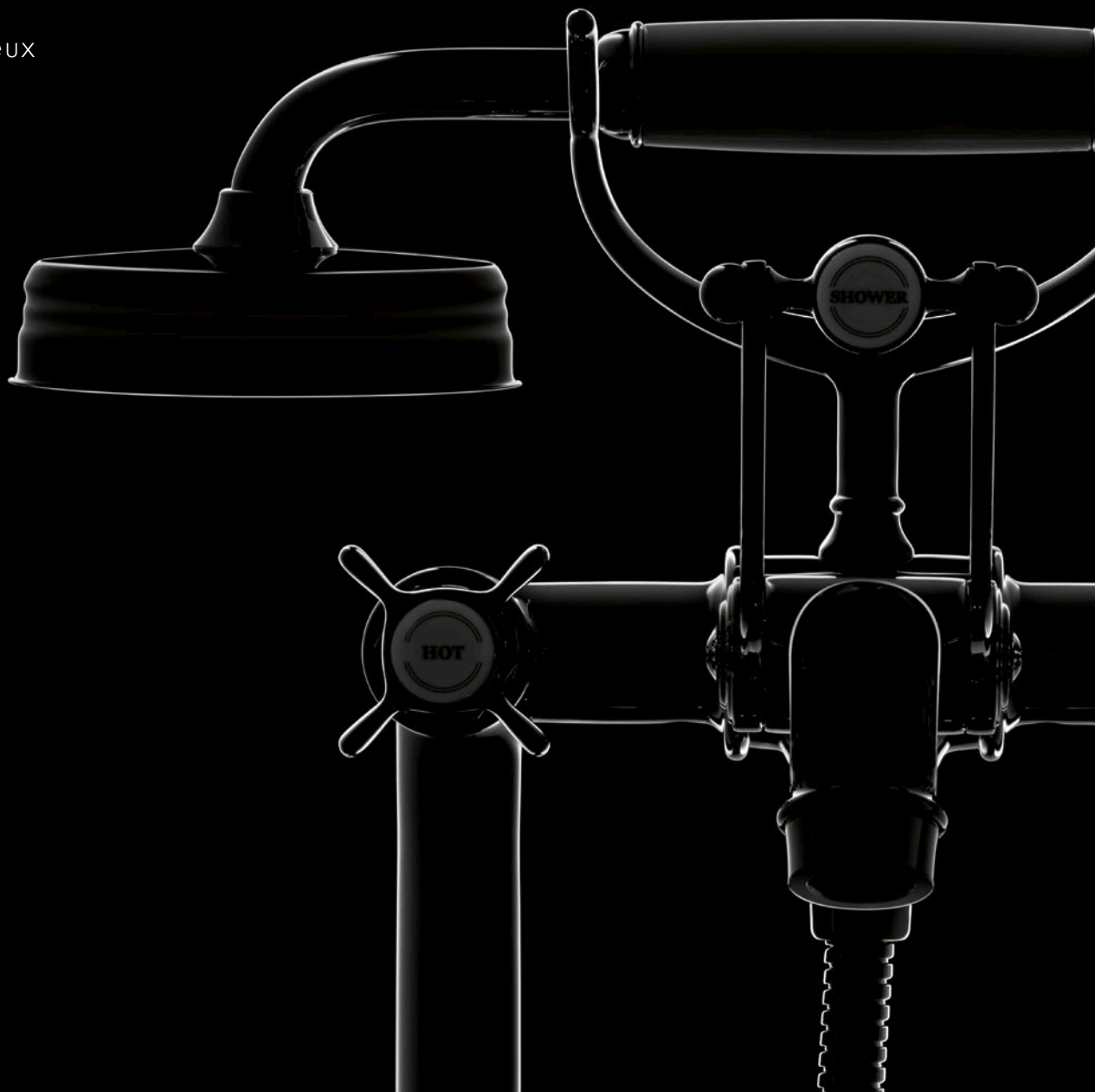



Further Axor Montreux products and information
can be found on our website.



Time recaptured

Axor Montreux draws its inspiration from the well-known spa resort on Lake Geneva. The traditional bathroom collection takes us back to the early 20th century and recaptures the spirit of the Belle Époque with its romantic spas.



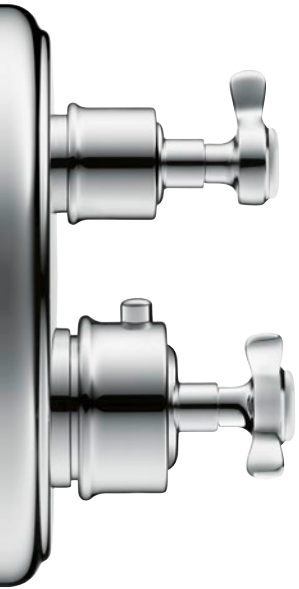

The authenticity of the classic design stems above all from the typical cross handles with their fine porcelain plates.



With loving attention to detail, the mixers recreate the traditional industrial design on the outside, concealing the state-of-the-art technology on the inside. The bath mixer revisits the style of its predecessor from the industrial era - a case in point being the porcelain handles on its hand shower.

A bathroom design that whisks you away to another time.











Programmes.

Looking for an exceptional shower? Or a new bathtub? In this chapter, you can find an overview of the wide range of Axor showers and other programmes, ordered according to function, that can be combined with the various Axor collections. Design objects that will continue to provide pleasure and comfort in the bathroom for many years to come.

Axor ShowerSolutions. *132–157*



	Axor ShowerCollection.	<i>134–137</i>
	Axor One.	<i>138–141</i>
	Axor ShowerSelect.	<i>142–145</i>
	Axor Shower systems.	<i>146–149</i>
	Axor Overhead Showers.	<i>150–153</i>
	Axor Shower sets and hand showers.	<i>154–157</i>

Axor Wash basins. *158–161*

Axor Bathtubs. *162–165*

Axor Electronics. *166–169*

Axor Accessories. *170–185*

	Axor Universal Accessories.	<i>172–173</i>
	Axor Starck.	<i>174–175</i>
	Axor Starck Organic.	<i>176–177</i>
	Axor Urquiola.	<i>178–179</i>
	Axor Massaud.	<i>180–181</i>
	Axor Bouroullec.	<i>182–183</i>
	Axor Montreux.	<i>184–185</i>



Axor ShowerSolutions

Axor ShowerSolutions open up an exclusive shower experience: here, the aesthetics of outstanding design meet sophisticated technology, which takes showering into a whole new dimension. Additional shower comfort also comes in the form of Select technology, which allows the showers to be operated easily at the touch of a button. There is a fascinating diversity in the products of different designs and sizes. They can all be combined perfectly with other Axor collections and programmes.

Axor ShowerCollection

Haute couture for the shower: with the Axor ShowerCollection designed by Philippe Starck, any shower can be transformed into a personal spa. A system of showers, mixers and accessories in a geometric and minimalist design offers virtually endless possibilities for design freedom. The individual, coordinated modules can be mixed and matched at will - be it in horizontal or vertical rows or according to aesthetic or functional concepts.





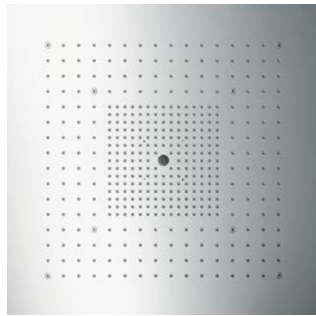

With its three different spray modes, the Axor ShowerHeaven overhead shower is a byword for luxurious showering and comes in two different sizes and either with or without lighting.



Bodyzone: the entire body is enveloped with a pleasant shower rain.



Central rain zone with AirPower function: the drops are enriched with air, creating a concentrated yet gentle shower rain.

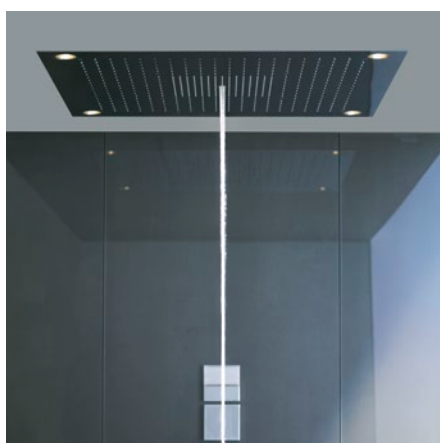

Laminar jet: the clear single jet is powerful and invigorating.



The combination of all spray modes creates the ultimate shower experience.



Further Axor ShowerCollection products and information can be found on our website.



Everything fits together: the shower modules can be used as overhead, neck or side showers. Convenient modules enhance the showering experience - from lighting to loudspeakers to shelf options.

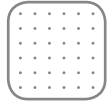

The shower modules are also available in a softcube design.

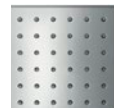

The waterfall spout is both a shelf area and a small spa. On the bathtub it is used for filling, in the shower the revitalising flood spray can be used for massaging the neck.







Axor One

Monoliths exude a majestic peacefulness, removing all but the bare necessities, so that the minimalist unique specimen leaves behind a reduced impression. Adopting this archaic form, Axor One represents a monolith in the shower. All elements are subjected to a strict code of simplicity, with all functions reduced to a central control element. Flat surfaces, gently rounded corners, generous proportions - Axor One is a confident statement that brings a spacious feeling into the shower, making it a haven of tranquillity.

Given the clear design language, Axor One is of course easy and intuitive to use. All that is needed to activate the various showers is a gentle tapping of the paddles with the finger, the back of the hand or even the elbow. Up to three different showers can be activated at the same time. This is thanks to Select technology, which focuses on tapping rather than turning. The symbol on each paddle indicates clearly which shower it controls.

One tap: a gentle tap on the paddles is all that is needed to control the required shower jet.

One turn: the temperature can be controlled precisely by the cylindrical handle and limited by the temperature lock.



One slide: sliding the small lever allows you to deliberately reduce the amount of water you use by up to 50%.



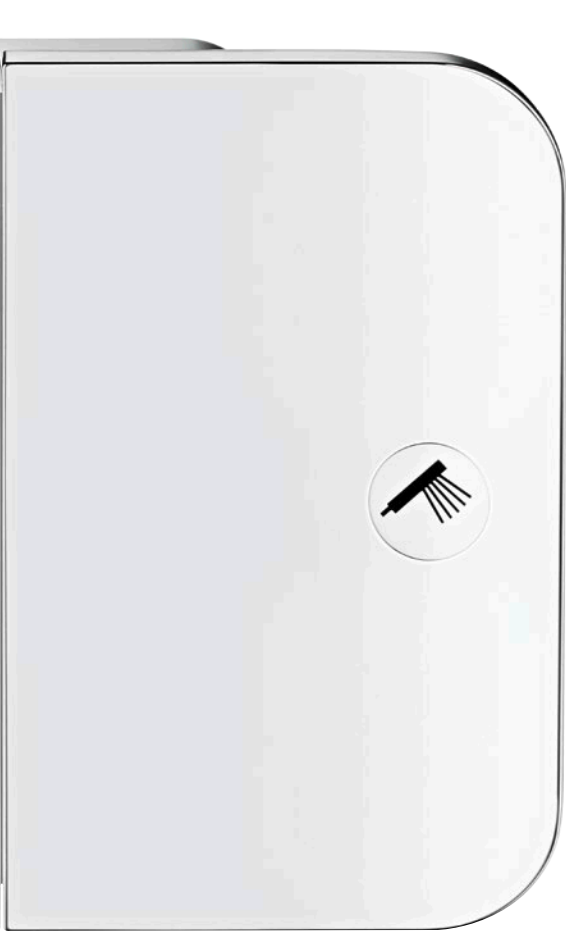

Thermostat module for three outlets, concealed installation



Thermostat module for two outlets, concealed installation



Thermostat module for one outlet, concealed installation

Axor ShowerSelect

A small button makes a great difference - and makes showering simpler and more convenient. Thanks to Select technology, the shower is now operated at the touch of a button. Tapping is the new turning: the various showers - such as the hand and overhead showers - are controlled intuitively using the select buttons. The Axor ShowerSelect thermostats boast elegant black select buttons with white symbols indicating which shower jet has been selected.





The clear and minimalist design of Axor ShowerSelect thermostats means that they can be used extensively and matched with many other products. At the same time, they add a note of elegance and premium quality to the shower. The thermostats come in a number of varieties: for one to four different showers or one bath spout.



Thermostat for concealed installation for 1 shower



The various escutcheon forms – “square”, “soft” and “round” – offer great scope for combining them with many different Axor collections.



Thermostat for concealed installation for 2 showers



Thermostat for concealed installation for 3 showers



Further Axor ShowerSelect products and information can be found on our website.



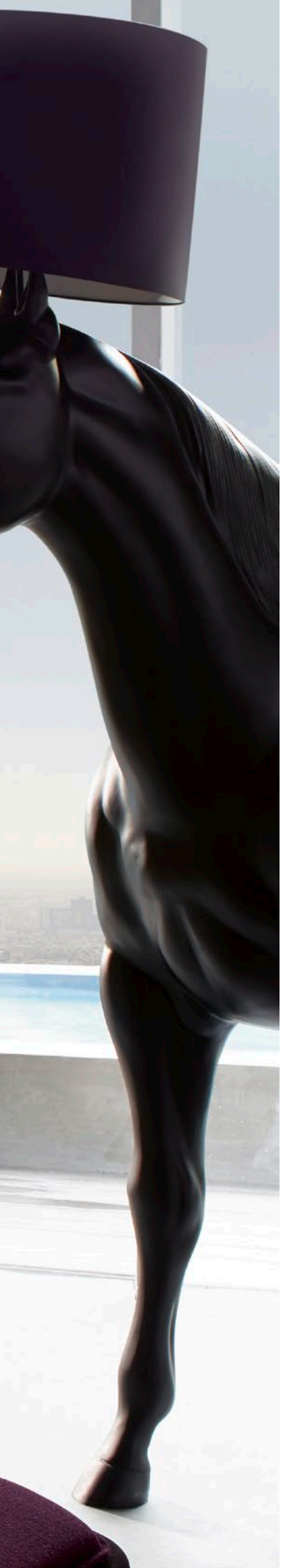

Axor Shower systems

Although we only actually need 30 seconds in the shower to get clean, the simple fact is: the longer we shower, the better we feel. Axor shower systems combine exclusive aesthetics with exceptional comfort. From the simple showerpipe to the shower column, it has all you need for the ultimate feel-good shower experience. Such as the Axor Showerpipe designed by Front, where state-of-the-art technology is packaged in a thoroughly appealing design.



The Axor Urquiola shower column seems to grow like a plant, with the asymmetrically arranged handles, shelf and overhead shower looking like small branches. The integrated shelf means that there is plenty of room for toiletries.

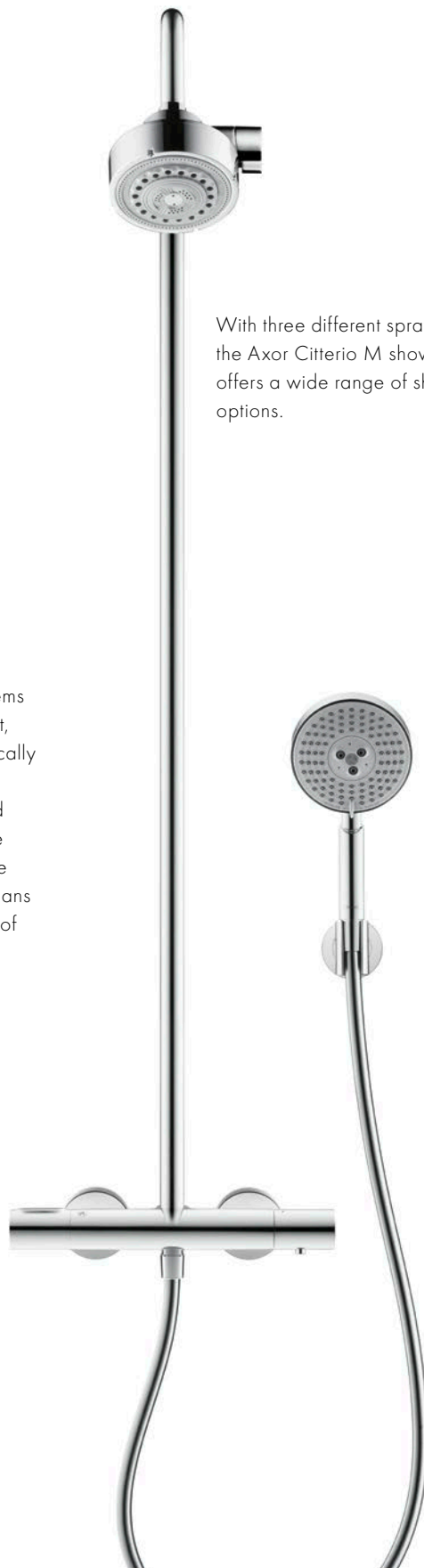

With three different spray modes, the Axor Citterio M showerpipe offers a wide range of shower options.

The Axor Starck shower column has a unique optical effect: it looks as if the water is coming directly out of the ground.

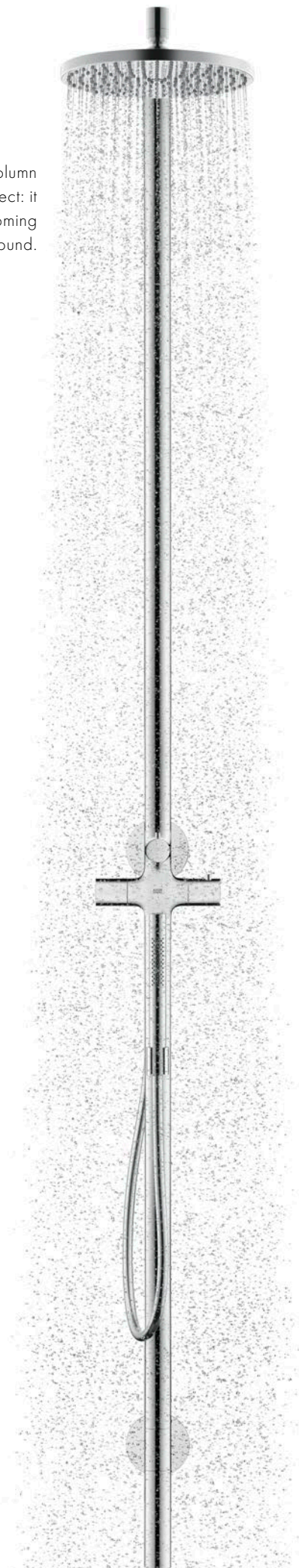

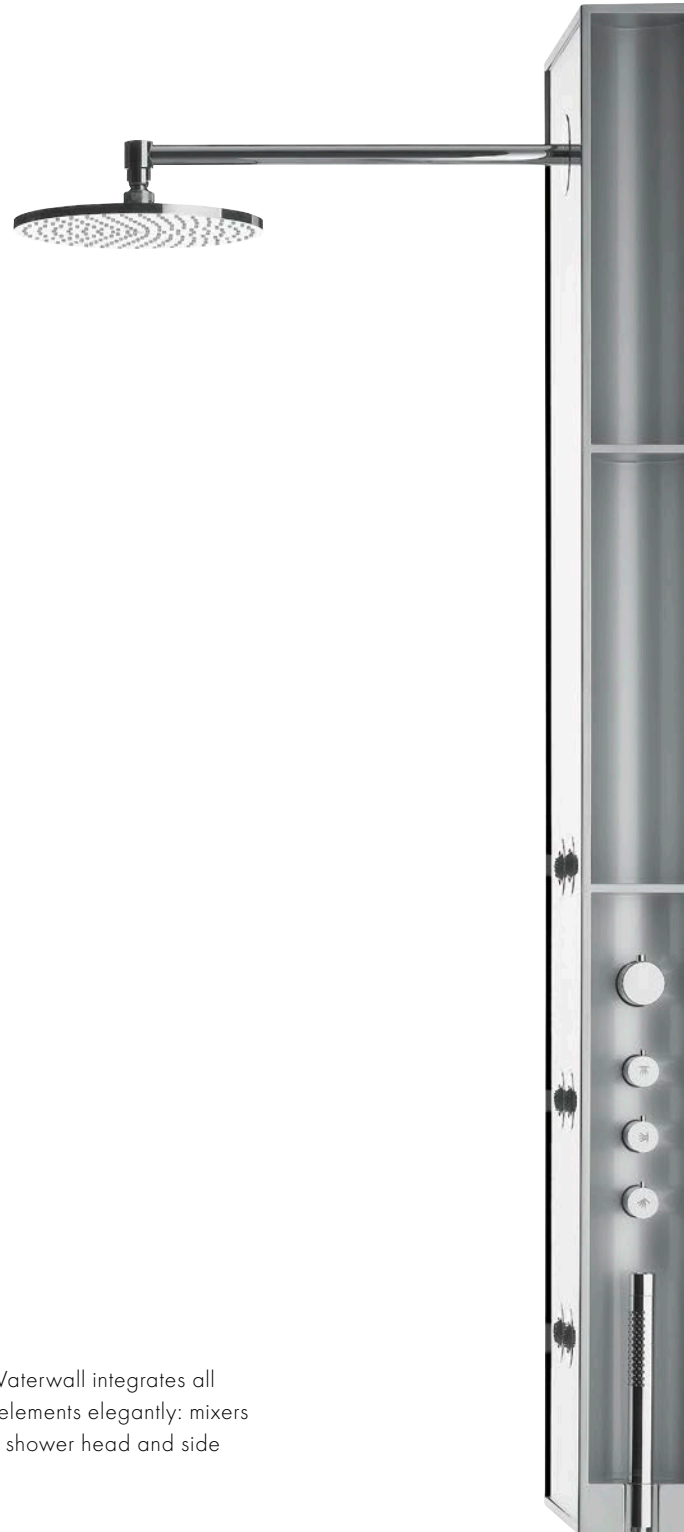

The Axor Starck Waterwall integrates all important shower elements elegantly: mixers and shelves, plate shower head and side showers.



Further Axor ShowerSolutions and information can be found on our website.

Programmes



Axor Overhead Showers

The sheer variety of the Axor overhead showers can be seen in their design, size, function and application. Whether round or square, massage spray or refreshing flood spray, soft or normal, wide or concentrated - the suitable overhead showers can be mounted on the wall or ceiling and are available with various spray modes. Axor LampShower designed by Nendo is a prime example: it does away with the usual borders between spaces as if by magic and lends a homely character into the bathroom.



With its authentic, traditional design, the Axor Carlton plate shower head fits harmoniously in traditional ambiances and creates a stimulating contrast in modern ones.



Axor ShowerProducts designed by Front: Industrial charm for the shower. In an exceptionally elegant form. We can see water routes in a whole new light, while a funnel becomes a well-proportioned overhead shower.



Available in two sizes – as either a ceiling- or wall-mounted version – the Axor Starck plate shower head adds a touch of minimalism to the shower.

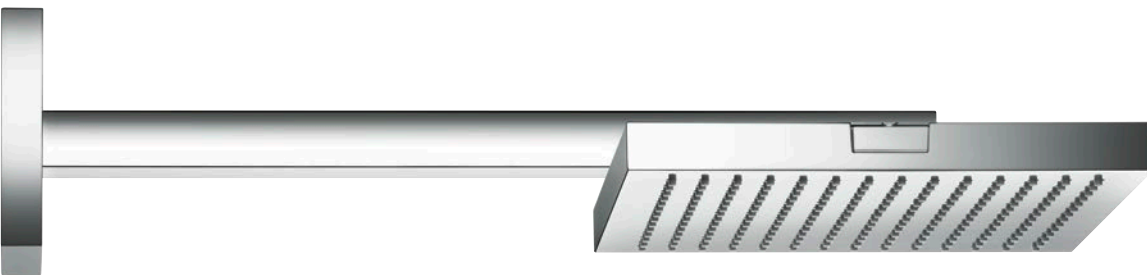

With its geometric and minimalist design, the Axor Starck overhead shower is an especially refined choice for the shower.

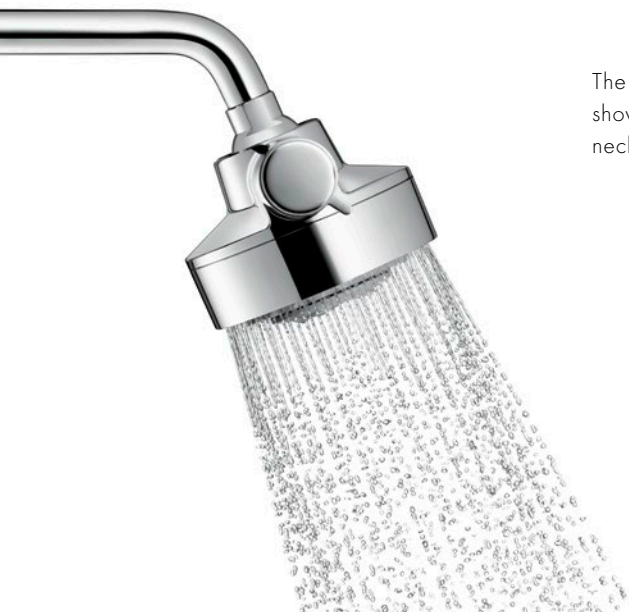

The ball joint allows the spray from the Axor Citterio overhead shower to be positioned perfectly to massage your back or neck – with a choice of three different spray modes.



Further Axor overhead showers and information can be found on our website.

Axor Shower sets and hand showers

Axor shower sets and hand showers make showering an even more comfortable experience. They are available in a variety of sizes and spray modes, which users can change easily by turning or tapping them. Not only that, with the right shower rail, the hand shower can be adjusted to the ideal height. A wide range of designers have left their mark, ensuring a unique look. For instance, the shower set designed by Front sets effortless accents in the shower. The pipes, sockets and valves – as were once commonplace in factories – are now used as design objects, bringing a touch of industrial charm to the bathroom.





The elegant, minimalist hand shower sets itself apart through its form, its concentrated sprays and its innovative rotary operation.



Further Axor shower sets and hand showers can be found on our website together with further information.



With its authentic handle and traditional look, the hand shower belonging to the Axor Montreux shower set sits perfectly with classical styles.



Axor Citterio E: With the elegant shower set and its double rail, the ergonomic and smooth-moving slider helps to adjust the shower to the required height.



Axor Wash basins

In addition to high-quality mixers, Axor produces wash basins in a variety of exotic designs such as wash bowls, built-in and wall-mounted wash basins. These came about while developing the respective Axor collections and can be combined with the mixers of the various bathroom collections.







With its integrated grab rails, the Axor Urquiola wash basin creates an appealingly nostalgic impression.



The round form of the Axor Urquiola wash bowl calls to mind those of times past.



With their flowing forms, the shelves integrated in the Axor Bouroullec wash basins provide additional space for toiletries.



The Axor Massaud wash bowl exudes organic naturalness - either as a built-in or counter-top version.



Further Axor wash basins and information can be found on our website.





Axor Bathtubs

An exceptional design idiom gives every bathtub an individual aesthetic and makes it the highlight of any bathroom - whether it is free-standing, built-in or wall-mounted. Different styles and materials - in combination with mixers from Axor collections - allow you to create your own individual design.



The archetypal shape of the free-standing, mineral-cast Axor Urquiola bathtub is reminiscent of old-style washtubs.



The Axor Bouroullec built-in bathtub has two shelves, allowing you to decide for yourself where to position the mixers.



The striking design of the Axor Citterio bathtub is founded on restraint, clarity and Italian elegance.



The free-standing Axor Massaud bathtub draws its inspiration from nature, giving you the feeling of diving into a lake.



Further information can be found on our website.

Axor Electronics

Axor electronic mixers are an elegant marriage of functionality and technology with exclusive design. The innovative sensor technology is integrated so discreetly that the mixer design can be reduced to the basics. Apart from this, the non-contact operation makes the mixers not only extremely hygienic but also economical: this is because the intelligent electronics only release water when it is actually needed, thereby helping to sustain this natural resource. For instance, the special design of the Axor Citterio electronic mixer makes its mark in high-class surroundings.

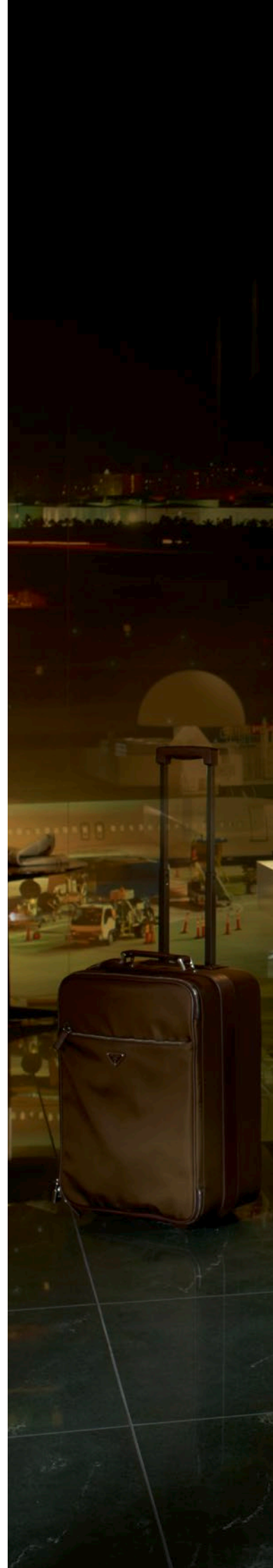



The minimalist Axor Uno² wall-mounted basin mixer as an electronic variant. With a sensor field on the bottom of the spout.



The electronic variant of the square Axor Starck X mixer has an almost sculptural look as well and is available either with or without temperature control.





With its organic, minimalist design, the Axor Starck Organic electronic mixer is especially effective at saving water: the voluminous mixer shower spray uses just 3.5 l/min. The mixer is available either with or without temperature control.



Also reduced to the basics is the electronic variant of the purist Axor Starck basin mixer, which is available either with or without temperature control.



Further information can be found on our website.

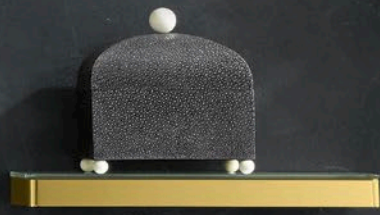



Axor Accessories

Axor bathroom accessories are all you need to create your own individual feel-good bathroom. They fit perfectly with all kinds of different styles and set their own unique accents: from practical shelves, towel racks and soap dispensers to elegant mirror lighting and much more besides. The high-grade accessories can be combined with many Axor collections and fulfil a variety of different comfort requirements. 15 special surfaces, which are manufactured exclusively by Axor Manufaktur, make it possible to make the accessories - and therefore also the shower - even more individual.



Further Axor accessories and information can be found on our website.



Axor Universal Accessories

Axor Universal Accessories are a real pleasure for anyone with an eye for the special things in **everyday life**. Shelves, bath towel rails and soap dispensers, clothes hooks all contribute to the *aesthetic* overall effect as well - *elegantly timeless* products that can be used individually or mixed and matched with one another. Thanks to their *universal design*, they blend in perfectly with many Axor collections and a wide range of styles.





Axor Starck

The accessories reflect Axor Starck's timeless, purist style and draw their inspiration from times long gone: for example, the towel hook calls to mind a simple nail.







Axor Starck *Organic*

The *organic, minimalist* design language of Axor Starck Organic also pervades the accessories: from the bath towel rail to the toothbrush tumbler, they set *harmonious accents* in any bathroom ambience.







Axor Urquiola

*Surfaces and **CURVES** also come together with a unique **CHARM** in the accessories of the **DETAILED** Axor Urquiola collection.*



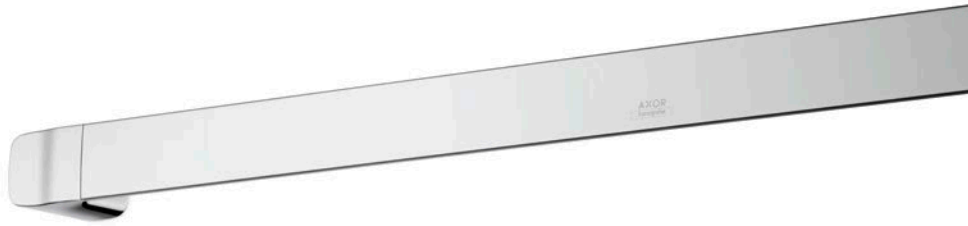



Axor Massaud





Accessories
in
the
Axor Massaud
collection
draw
their
inspiration
from
nature:
the
towel
rack
becomes
a *bough*,
the
vanity
box
a *pebble*,
even
the
mirror
is
supported
by
a *branch*.



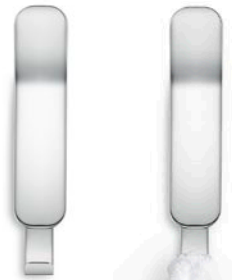

Axor Bouroullec

The accessories in the Axor Bouroullec collection are set apart by their refined, elegant design - all the way to the gently curved shelves that offer plenty of additional space for storage.





Axor Montreux

Above all, the traditional, authentic design of Axor Montreux Accessories is ideal for creating classic ambiances. Especially true to the original style is the retractable shaving mirror.



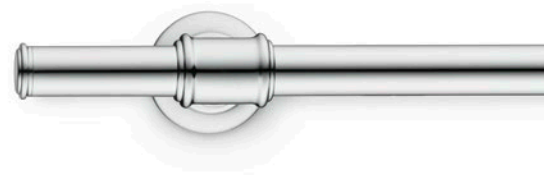

Where
chrome
can be PLATED
WITH GOLD.

A black mixer? An extended shower arm? Individual lettering? The exclusive services offered by Axor Manufaktur allow ample scope for individualisation - at the very highest level. Created with loving attention to detail, these customised products are a prime example of a marriage between craftsmanship and high technology.



Manufacturing quality

Axor Manufaktur is synonymous with exclusivity, durability and premium craftsmanship. Skill and instinct meet state-of-the-art technology. You would be surprised to learn just how much work on Axor product is done by hand: for example, no fewer than 146 individual components are assembled by hand to form the Axor LampShower. And the exclusive polished gold-optic special surface also comes about through made-to-order production - made in Germany by Axor Manufaktur.

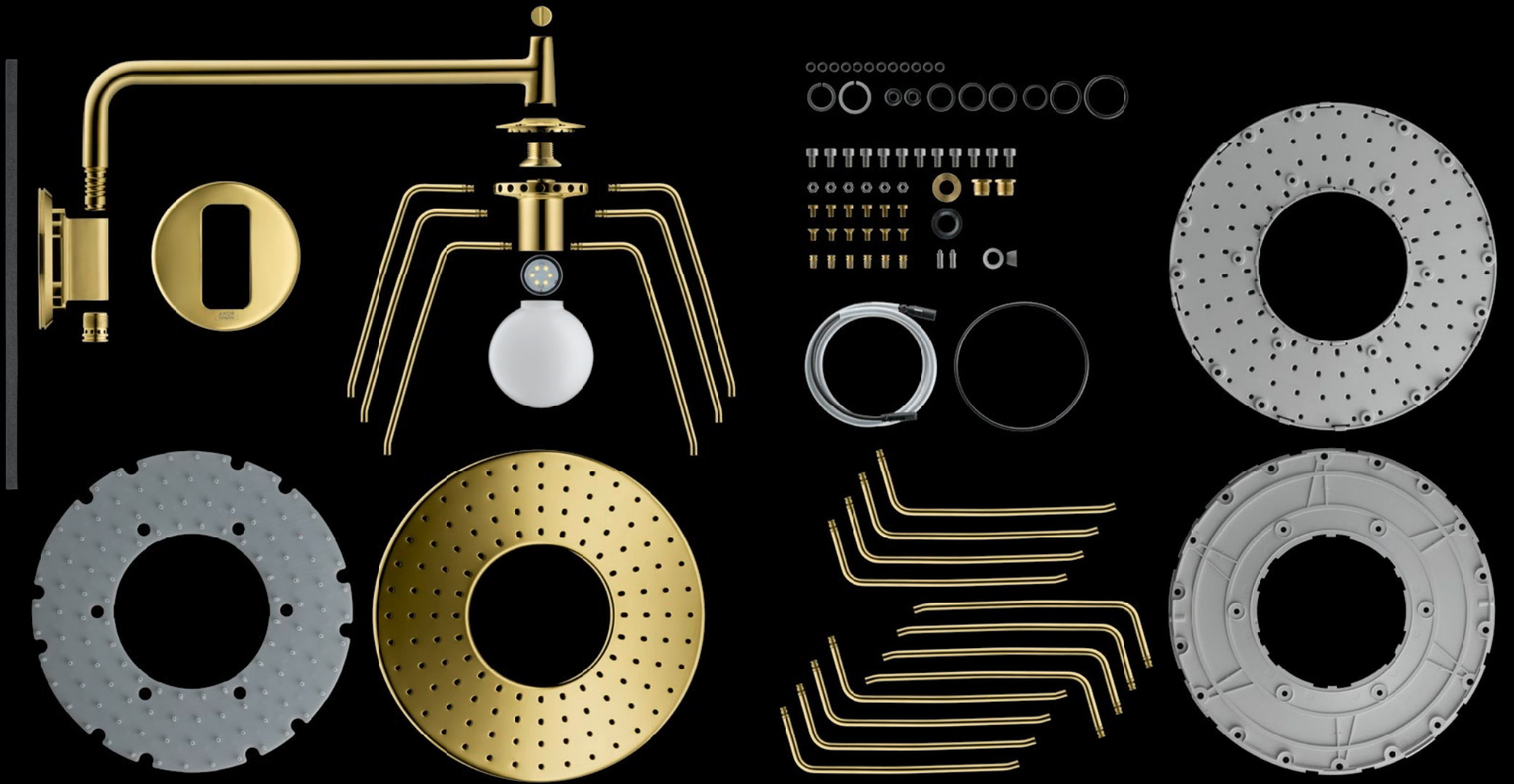



Special surfaces

Custom finishing for Axor products increases the scope for individual design possibilities in the bathroom. Finishings created using the state-of-the-art PVD (Physical Vapour Deposition) technology are ten times as hard as standard chrome as well as being extremely durable and having an exceptionally brilliant finish. In addition to the 15 special surfaces, customers can have their own surfaces made to order.



Polished
chrome



Brushed
chrome



Polished
gold-optic



Brushed
gold-optic

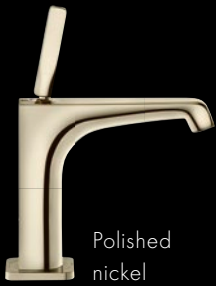

Polished
nickel



Brushed
nickel



Polished
rose gold



Brushed
rose gold



Polished
bronze



Brushed
bronze



Polished
black chrome



Brushed
black chrome

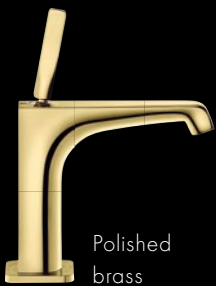

Polished
brass



Brushed
brass



Stainless steel
optic



If the colour you are looking for is not one of the standard special surfaces, you can have your own surface made to order with the colour of your choice.



Special lettering

Lettering and symbols make it easier to operate mixers and showers. For example, with symbols for hand and overhead showers, with additional hot-cold markings or larger, more legible designations. Logos, monograms and coats of arms in various designs can also be used to personalise products.

Examples for overhead/hand shower markings

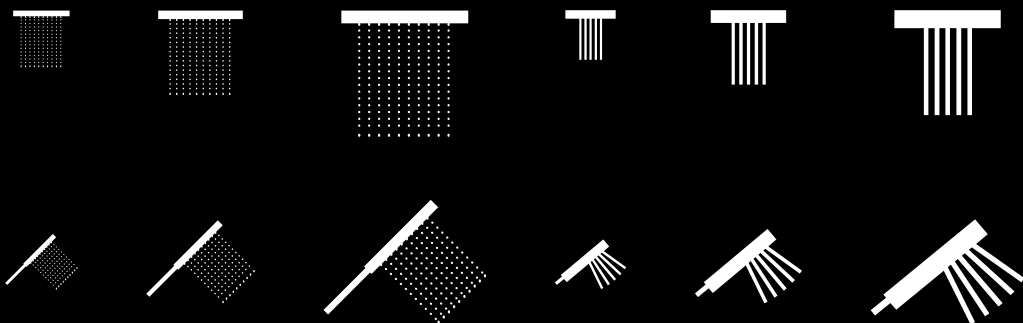

Examples for temperature markings



Examples for branding



Adapting lengths

Is the spout too long? Or the shower arm too short? Or you prefer to have an exclusive unique specimen? A bathroom product must be perfect in every regard. For instance, it can be shortened or lengthened to fit the exact dimensions of the bathroom in question. The length adaption service offered by Axor Manufaktur adds an element of freedom to designing your individual bathroom – as well as fulfilling original requests.

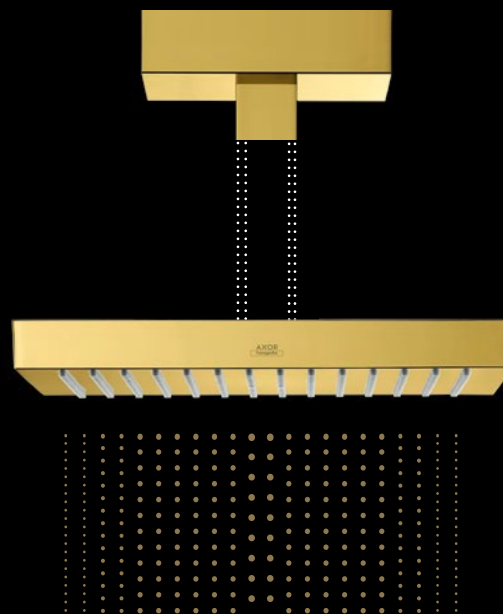

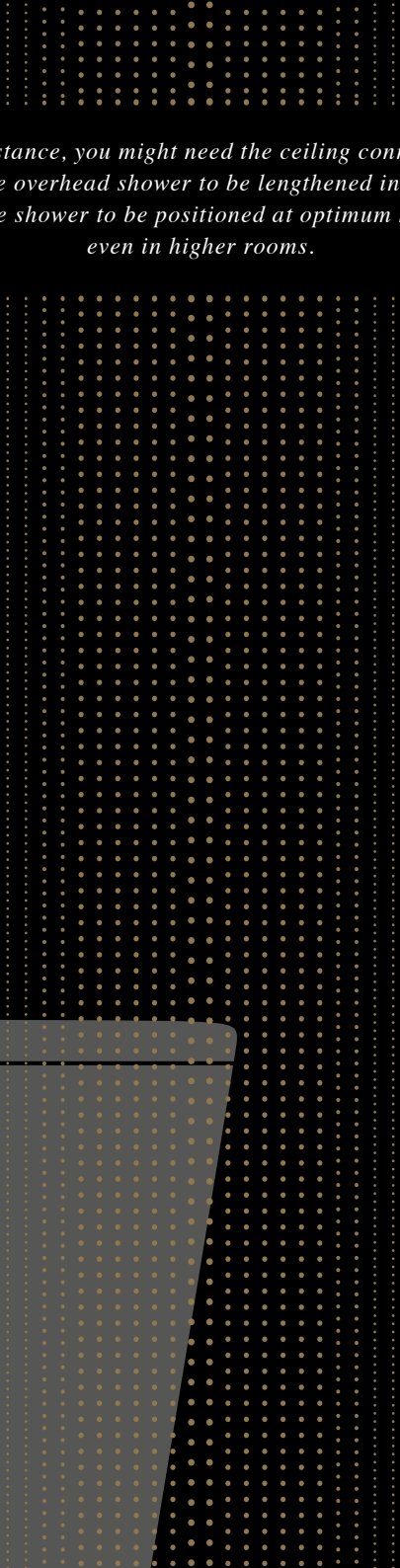

For instance, you might need the ceiling connection for the overhead shower to be lengthened in order for the shower to be positioned at optimum height even in higher rooms.



The bath spout can be lengthened in such a way that it bridges gaps perfectly – e.g. the gap created by a brick-built shelf between the wall and the bathtub.

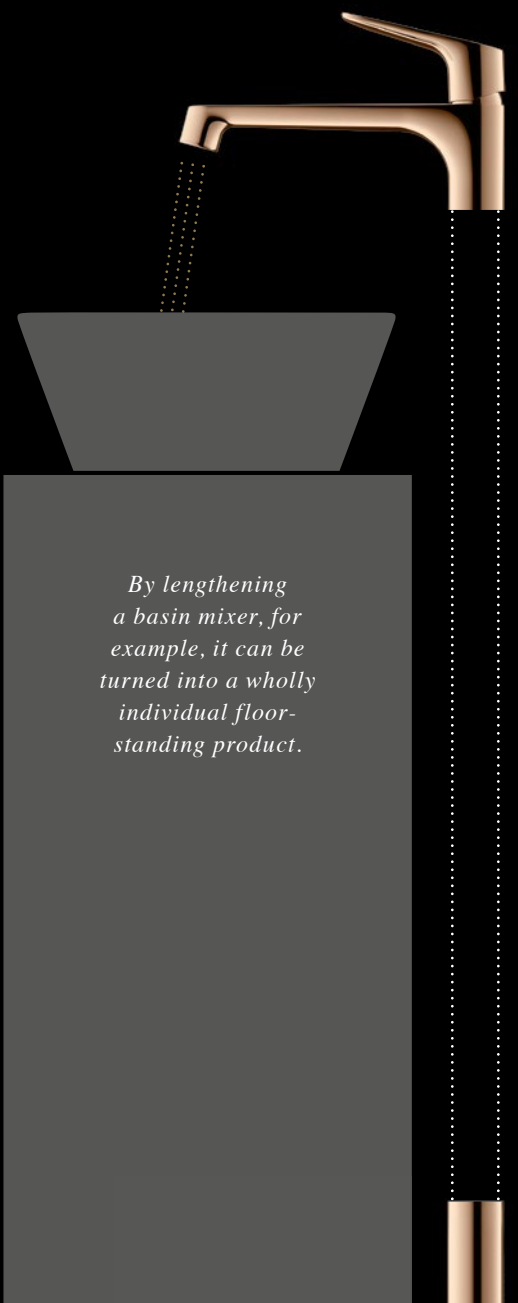

By lengthening a basin mixer, for example, it can be turned into a wholly individual floor-standing product.

25hours

Hotel, Zurich/Switzerland /

Aloft, Abu Dhabi/UAE / Asia Therme,

Linsberg/Austria / Atmosphères Hotel, Paris/France /

Banyan Tree, Lijang Yunnan/China / Barceló Harrogate Majestic,

Harrogate/United Kingdom / Barvikha Hotel, Moscow/Russia / Belvédère

Strandhotel & Restaurant, Spiez/Switzerland / British Airways Lounge Terminal 5,

London/United Kingdom / Budersand Hotel Golf & Spa, Sylt/Germany / Bulgari Hotels

& Resorts, London/United Kingdom, Milan/Italy, Bali/Indonesia / Burj Khalifa, Dubai/

UAE / Casa Camper, Barcelona/Spain / Château Bethlehem, Maastricht/Netherlands / Chelsea

Club, London/United Kingdom / Else Club, Moscow/Russia / Estadio Chivas, Guadalajara/Mexico /

Fairmont Grand Hotel Kyiv, Kiev/Ukraine / “Flame Towers” Fairmont Hotel, Baku/Azerbaijan / Four

Seasons Park Lane, London/United Kingdom / Franz Liszt Academy of Music, Budapest/Hungary /

Frederik VIII’s Palace Amalienborg, Copenhagen/Denmark / Gateway Hong Kong Marco Polo Hotels,

Hong Kong/China / Grand Hotel Savoy, London/United Kingdom / Grand Hyatt, Goa/India / Hamilton Scotts,

Singapore / Hilton Istanbul Kozyatagi Conference Centre & Spa, Istanbul/Turkey / Hilton Melbourne South

Wharf Hotel, Melbourne/Australia / Hotel Carlton, St. Moritz/Switzerland / Hotel Intercontinental, Hangzhou/

China / Hotel Silken Puerta América, Madrid/Spain / House Buys, Leopard Creek/South Africa / Hyatt Capital

Gate, Abu Dhabi/UAE / JW Marriott Hotel Bengaluru, Bangalore/India / Jumeirah Creekside Hotel, Dubai/

UAE / Kau Manor, Harjumaa/Estonia / Kempinski Hotel, Yixing/China / Kise Bettei Hotel, Okinawa/Japan /

Mandarin Oriental, Barcelona/Spain / Palais Hansen Kempinski, Vienna/Austria / Palazzo Parigi, Milan/

Italy / Parkroyal on Pickering, Singapore / Phinisi The Zen Yacht, Hong Kong/China / Restaurant Geist,

Copenhagen/Denmark / Ritz-Carlton, Montréal/Canada / Seven Stars Galleria, Milan/Italy / SLS Hotel

South Beach, Miami/USA / Sofitel Dubai Jumeirah Beach, Dubai/UAE / Sofitel Dubai The Palm Resort

& Spa, Dubai/UAE / Stamford Residences, Sydney/Australia / Sunseeker Yachts, Southampton/United

Kingdom / Suisse Majestic Hotel, Montreux/Switzerland / The Beach House Manafaru, Maldives /

At home in the **world’s** most *beautiful* buildings.

The Chedi, Andermatt/Switzerland / The Mirror, Barcelona/Spain / The Silverstein

Home, Atlanta/USA / Turning Torso, Malmö/Sweden / Villa Magnolia, Mougins/

France / W Hotel, Taipei/Taiwan / W Hotel Opéra, Paris/France / Waldorf

Astoria, Berlin/Germany / Weissenhaus Grand Village Resort &

Spa am Meer, Weissenhaus/Germany / Yoo Apartments,

Hamburg/Germany, Pune/India, New York/USA

etc.

The Jane, Antwerp/Belgium: Modern elements and the luster of old churches come together in the new gourmet restaurant in Antwerp. In the former chapel, Dutch interior designer Piet Boon created an aesthetic marriage of art and cuisine: the high-end character of the restaurant is accentuated by the historic floor mosaic with the striking glass cube that houses the show kitchen featuring star cooks Sergio Herman and Nick Bril. Elegant in finish and purist in form, the Axor mixers – in the modern special surface of brushed black chrome – make a key contribution to the state-of-the-art design of the restaurant.



- Interior designer: Piet Boon, Amsterdam/Netherlands
- Collections: Axor Uno² electronic wall-mounted basin mixer and Axor Citterio SemiPro kitchen mixer in brushed black chrome, with a special finish added in the Axor Manufaktur
- Seats: 65



The Jane, Antwerp/Belgium



Spa in the Four Seasons Hotel, Milan/Italy: The 5-star hotel's luxury spa is steeped in Roman bath culture: the historic vaulted cellar of a 15th century monastery is preserved in all its original glory, complete with pillars, arches and brick ceilings. On an area measuring 800 square metres, you can relax and while away the time in a generously proportioned pool and neighbouring quiet zone. The Axor mixers were finished in elaborate brushed gold-optic and fit perfectly with the sensual luxury of the spa.



- Interior designer: Patricia Urquiola, Milan/Italy
- Collections: Axor ShowerCollection and Axor Urquiola in brushed gold-optic from the Axor Manufaktur
- Area: 800 m²





Porta Nuova Residence, Milan/Italy: The urban large-scale project in a former industrial wasteland informs the Milan skyline with its sky-scraping towers. A new quarter, comprising both a residential and commercial area, was built on a total area of 290,000 m². The residential towers – Aria, Solaria and Solea – not only offer a breath-taking view from the cathedral to the Alps, but their room concept also exudes a timeless style of living. With their outstanding design quality, Axor bathroom fittings complete the exclusive bathrooms in four different styles.



- Architects: Arquitectonica, Miami/USA, Caputo Partnership, Milan/Italy
- Interior designers: Coima Image, Antonio Citterio Patricia Viel and Partners, Milan/Italy, Dolce Vita Homes, Edmonton/Canada
- Collections: Axor Citterio, Axor Citterio M, Axor Uno², Axor Starck, Axor Montreux





Porta Nuova Residence, Milan/Italy

Kapama Southern Camp, Hoedspruit/South Africa: Guests at the Kapama Southern Camp in the Safari Park between the Drakensberg and Kruger National Park can relax in the luxurious surroundings of a five-star hotel. The suites and the lounge and restaurant in the Kapama Game Reserve offer a fantastic view of the African bush and savannah landscape and are designed in authentic African style, drawing inspiration from nature. In keeping with this, the luxurious bathrooms are equipped with organically minimalist Axor Starck Organic mixers.



- Interior designers: Gigi's Design House
- Collection: Axor Starck Organic
- Rooms: 15 luxury suites





Kapama Southern Camp, Hoedspruit/South Africa

Campbells Pocket Residence, Moreton Bay/Australia: This residence in Queensland has a unique view of the Glass House Mountains, famous for their picturesque surroundings, tropical climate and green nature. In accordance with the owner's wishes, the house has been integrated within the natural environment. This means that all elements were carefully selected or individualised according to environmentally friendly specifications. The Axor products, which were specially finished by Axor Manufaktur with the classy surface bi-colours brushed bronze/matt black, are also customised and designed to save water.



- Architects/interior designers: Ultraspace Architecture and Interior Design
- Collections: Axor Starck and Axor Starck Organic in bi-colour brushed bronze/matt black, specially finished by Axor Manufaktur





Campbells Pocket Residence, Moreton Bay/Australia

Imprint

Publisher:

Axor, Hansgrohe SE, D-Schiltach

Concept/design:

bilekjaeger, Stuttgart

Typesetting:

bilekjaeger, Stuttgart; Stolz-Krechting, Lahr

Bathroom planning:

Ronan & Erwan Bouroullec, Paris;

Antonio Citterio, Mailand;

Matthias Eck, Radolfzell;

Peter Fehrentz, Hamburg;

fön design, Schramberg;

Rolf Heide, Hamburg;

Ippolito Fleitz Group, Stuttgart;

Peter Kräling, Hamburg;

Jean-Marie Massaud + Daniel Pouzet, Paris;

Studio Urquiola, Mailand

Photography:

Morgane Le Gall, Nicolas Guerin, Rainer Horsch, Christoph Kicherer,

Kuhnle & Knödler, Uli Maier, Bernd Opitz, Alessandro Paderni,

Wolfgang Scheppe, Rudolf Schmutz, Michael Schnabel, Alexander Schneider,

Paul Tahon, Gionata Xerra, Alisa Connan

Photography reference sites:

The Jane, Antwerpen, Belgien - Fotoclair;

Four Seasons Spa, Mailand, Italien - Kuhnle & Knödler;

Porta Nova Residence, Mailand, Italien - Kuhnle & Knödler;

Kapama Southern Camp - Kapama Private Game Reserve;

Campbells Pocket Residence, Moreton Bay, Australien -

Mark Gecesa of Ultraspace/Fotograf: David Sproulev

Lithography:

Eder GmbH, Ostfildern

Print:

B&K Offsetdruck, Ottersweier

Special thanks to:

B&B Italia, Burgbad, Duravit, Flexform, Florim, Graniti Fiandre, GTdesign,

Kaldewei, Keramag, Laufen, LEA Ceramiche, Niessing Living Jewelry Culture,

Royal Mosa

Axor – Hansgrohe SE · Postfach 1145 · D-77757 Schiltach
Telefon +49 7836 51-0 · Telefax +49 7836 51-1300 · info@axor-design.com · www.axor-design.com

Argentina – Hansgrohe S.A. · Av. del Libertador 14.323 · Martínez · B1640APB · Buenos Aires · Argentina
Tel. +54 11 4733 2400 · Fax +54 11 4733 2499 · info@hansgrohe.com.ar · www.hansgrohe.com.ar

Australia – Hansgrohe Pty Ltd · Level 1 · 123 Camberwell Rd · East Hawthorn · Victoria 3123 · Australia
Tel: +61 3 9811 9971 · info@hansgrohe.com.au · www.hansgrohe.com.au

China – Hansgrohe Sanitary (Shanghai) Products Co. Ltd · No. 2999 Shenggang Road · CN-201611 Shanghai
Tel. +86 021 3774 2200 · Fax +86 021 3774 2202 · info@hansgrohe.com · www.hansgrohe.com.cn

Cyprus – Hansgrohe Middle East & Africa Ltd. · Pentadakilou Street 2 · Office 104 · CY-7101 Larnaca (Aradippou)
Tel. +357 24 813081 · Fax +357 24 813031 · me.support@hansgrohe.com · www.hansgrohe-middleeast.com

Estonia – Hansgrohe Eesti · Mäealuse 2/1 · EE-12618 Tallinn · Tel. +372 6826829
Fax. +372 56000055 · info@hansgrohe.ee · www.hansgrohe.ee

Hungary – Hansgrohe Kft. · 1139 Budapest · Forgách u. 11-13. · Telefon +36 1 2369090
Telefax +36 1 2369098 · info@hansgrohe.hu · www.hansgrohe.hu

India – Hansgrohe India (pvt.) Ltd. · Office Nos. 601-604 · Sky Station · Viman Nagar · 411 016 Pune · Maharashtra · India
Tel. +91 20 6625 9500 · info@hansgrohe.in

Japan – Hansgrohe Japan K.K. · Tennozu First Tower 2F · 2-2-4 Higashi Shinagawa · Shinagawa-ku · Tokyo · Japan
Tel. +81 3 5715-3073 · Fax +81 3 5715-3088 · info@hansgrohe.co.jp · www.hansgrohe.co.jp

Kazakhstan – Hansgrohe · г.Алматы · Бостандыкский район · «Микрорайон КЕPEMЕТ» · дом No 1, часть A3
телефон +7 727 315 09 16 · info@hansgrohe.kz · www.hansgrohe.kz

Latvia – Hansgrohe Latvijas pārstāvniecība · SIA Aqua Studio · Raiņa iela 14 · LV-3913 · Iecava
Tālrunis +371 29229029 · Fakss +371 63942251 · info@hansgrohe.lv · www.hansgrohe.lv

Lithuania – Hansgrohe atstovybė · Santoza · Ulonų g. 5 · LT-08240 Vilnius · Tel. +370 5 2043291
Faksas +370 5 2043293 · info@santoza.lt · www.hansgrohe.lt

Mexico – Hansgrohe · S. de R.L. de C.V. · German Center 0-2-02 · Av. Santa Fe No. 170
Col. Lomas de Santa Fe · 01210 México, D.F. · Tel. +52 55 5261-4191
Fax +52 55 5261-4199 · info@hansgrohe.com.mx · www.hansgrohe.com.mx

South Africa – 30 Archimedes Street · Kramerville · Johannesburg · South Africa 2090
Tel: +27 11 445 0000 · Fax: +27 11 445 0199 · sales@hansgrohe.co.za · www.hansgrohe.co.za

Singapore – Hansgrohe Pte. Ltd. · 69 Mohamed Sultan Road · Singapore 239015
Tel. +65 6884 5060 · Fax +65 6884 5071 · info@hansgrohe.com.sg · www.hansgrohe.com.sg

Sweden – Hansgrohe AB · Svngatan 2B · S-416 68 Göteborg · Tel. +46-31 21 66 00
Fax. +46-31 19 01 03 · info@hansgrohe.se · www.hansgrohe.se

United Kingdom – Hansgrohe Limited · Units D1 and D2 · Sandown Park Trading Estate · Royal Mills
Esher · Surrey · KT10 8BL · Tel. +44 (0) 1372 465 655 · Fax +44 (0) 1372 470 670
enquiries@hansgrohe.co.uk · www.hansgrohe.co.uk



en-Axor catalogue 2016 · Subject to technical alterations and colour differences due to the printing process.
Form-Nr. 84.090.398 · 10/15/30.255 · Printed in Germany · Printed on 100% chlorine free bleached paper. CO₂ compensated print.

